

都汇里

HC28 COSMO

HOME COLLECTION







HOTEL

CITY SPEED LIMIT 25

都汇里，用“简约”的语言，重塑“奢华”的维度，与众多国际设计大师 Christophe Delcourt, Yonoh, 梁志天 Steve Leung 和 Roderick Vos 等，创造出高级有机，时尚有趣和优雅大气的现代家具系列，并以突破性的视角和国际化水准的精湛工艺，诠释高级奢华和新鲜多元的都会生活。

HC28 COSMO is a unique brand reinterpreting sleek luxury in modern and sophisticated style. Collaborating with renowned designers like Christophe Delcourt, Yonoh, Steve Leung and Roderick Vos, the brand has developed a versatile, trendy, fresh and elegant furniture collection. By its art of craft, HC28 COSMO represents a new cosmopolitan lifestyle in high quality and versatility.



## DESIGNER

设计师

06-13

---

## LIVING ROOM

客厅

14-49

## DINING ROOM

餐厅

50-67

## BEDROOM

卧室

68-85

---

## PRODUCT INDEX

产品目录

86-145

# In conversation with STEVE LEUNG 梁志天

当代中国设计的领军人物

A leading character in contemporary design in China



**Q: 在为 HC28 都汇里 创作的过程中，令您印象最深刻的事情是什么？**

A: 印象最深刻的是我和团队在创作过程中的思考。“都汇里”是一个体现都市精神的系列。都市大多给人一种喧嚣、复杂的印象，所以我们希望通过这个作品展现出都市生活的另一面：生机勃勃、充满机遇、格调不凡。我们透过极简现代的设计，流畅及有节制感的曲线来塑造这些气质，创造出一组现代优雅而又有温度的作品。

**Q: 您为 HC28 都汇里 设计的产品的主人是什么样的？您希望通过您的作品传达给用户哪种生活方式和观念？**

A: “都汇里”的主人，一定是一个注重生活品质的人，懂得在繁忙的都市生活中，静下来享受生活之美。同时，也会是一个非常 有想法，不轻易随波逐流的人，对自己的品味十分自信。

我希望用户可以从我们的作品中感受到都市生活的另一面，充满活力，格调不凡，那是一种积极进取，勇于开拓的都市精神。

**Q: 您此次为 HC28 都汇里 设计的产品系列，有什么特别的意义？**

A: 这个系列的名字很有趣，叫做“UOVO”，是意大利语中“蛋”的意思，因为我们的设计灵感就是来自于像鸡蛋一样柔润流畅的线条和造型，让人感觉放松舒适，优雅之余也不失玩味。同时，蛋也是生命孕育的开始，寓意着活力和希望，又充满惊喜，就像都市中的年轻人。这个系列的现代极简设计和灵活组合，正展现了这些气质和态度。

**Q: 在您眼中，HC28 都汇里 是一个什么样的品牌？可以用一句话或几个词概括一下吗？**

A: “都汇里”就像一颗漫步在曼哈顿 SOHO 的年轻跳动的心。它有活力、有态度、有温度。





**Q: What was the most impressive thing during cooperation with HC28 COSMOPOLITAN?**

A: I'm delighted by how our team drives the creation and the thoughts of it. The brand is a collection that presents the spirit of metropolitan life. A metropolis is often bustling and complex. We hope to present the other side of metro life: one marked by vitality, opportunity, and unique tastes. We use controlled curves to create a simple but modern shape and look. The collection is fun, elegant, and with character.

**Q: What do you think the HC28 COSMOPOLITAN users look like? What lifestyles and ideas do you hope to convey to users through your design?**

A: The brand furniture owners lead a quality life. They take time to slow down and enjoy the beauty of life. They are leaders who set the trends with their distinctive tastes rather than following them.

In this new collection, we hope to bring users the dynamism and character of a metropolitan life. It is a place where people create, break through and appreciate sophistication.

**Q: Does your design for HC28 COSMOPOLITAN have any special meaning?**

A: Our new collection "UOVO" which means "egg" in Italian, is inspired by its smooth and controlled curves. It also symbolizes the beginning of a new life that's vibrant, hopeful and often surprising, similar to the young metropolitans. Our contemporary and minimal design with flexible compositions represents this attitude.

**Q: In your eyes, what kind of brand is HC28 COSMOPOLITAN? Can you summarize it briefly?**

A: The brand is a beating young heart in SOHO of Manhattan. It is energetic, charismatic and genuine.

# In conversation with CHRISTOPHE DELCOURT

---

天才设计师  
A gifted designer



**Q: 在为 HC28 都汇里 创作的过程中，令您印象最深刻的事情是什么？**

A: 这次合作中最令人惊叹的是厉先生和其团队的工作热情和力量，我们的交流非常顺畅，每次工厂讨论样品的会议总是收获颇丰，他们对于我的意见，甚至苛求始终全力配合。

**Q: 您为 HC28 都汇里 设计的产品的主人是什么样的？您希望通过您的作品传达给用户哪种生活方式和观念？**

A: “都汇里”面向的人群是那些热爱旅行、深谙文化与时尚之道的人，“都汇里”通过这些精致的作品和独有的细节，服务于那些对品质要求极高的人群。

**Q: HC28 都汇里 在您眼中是一个什么样的品牌？**

A: “都汇里”是一个处于潮流前沿，于细节中彰显鲜明个性的现代家具品牌。

**Q: What was the most impressive thing during cooperation with HC28 COSMOPOLITAN?**

A: Ce qui m'impressionne le plus est la force de travail de Mr LI et de ses équipes. Les échanges sont très fluides et les réunions autour des prototypes à l'usine sont toujours très productives. Il y a une véritable écoute par rapport à mes demandes et parfois mes exigences.

**Q: What do you think the HC28 COSMOPOLITAN users look like? What lifestyles and ideas do you hope to convey to users through your design?**

A: HC28 COSMOPOLITAN s'adresse à une clientèle qui voyage beaucoup et qui s'intéresse à la culture, à la mode...HC28 COSMOPOLITAN par ses détails et ses finitions sophistiqués se fait l'écho d'une clientèle exigeante.

**Q: In your eyes, what kind of brand is HC28 COSMOPOLITAN? Can you summarize it briefly?**

A: HC28 COSMOPOLITAN est une marque de mobilier contemporain aux lignes actuelles composées de détails qui lui confère une identité singulière.



# In conversation with SEBASTIAN HERKNER

---

传统工艺的“创新者”  
An innovator of traditional artisanry



传统工艺与现代设计之间的桥梁，是新生力量的代表。

1981 出生的德国设计师 Sebastian Herkner 作为德国奥芬巴赫设计学院（Offenbach University of Art and Design）的优秀毕业生，通过独特的造型、经典的材料以及拼接的色彩，为德国乃至世界带来了全新的设计，并柔化了“德国设计”在大众心中的形象，更在 2019 年被评选为 MAISON&OBJET PARIS 年度设计师。

2006 年他成立工作室以来，为众多知名家具品牌设计产品，如意大利家具品牌 Moroso、德国户外家具品牌 Dedon、德国百年家具品牌 Thonet，以及荷兰家居品牌 Lintello 等。

2020 年，Sebastian Herkner 携手都汇里品牌，设计了如 BERLIN 柏林沙发、GEM 合璧扶手椅、GRASSI 格萨茶几等一系列精彩作品，兼顾传统与现代的设计，对色彩的独到眼光，注重不同文化的融合，这些内涵都在这些作品中表达的淋漓尽致。

Sebastian Herkner (born 1981) studied Product Design at HfG Offenbach University of Art and Design. During his studies he began to focus on designing objects and furniture, honing his keen sense for materials, colors and textures. For a short while he then worked for Stella McCartney in London.

In the year 2006 Sebastian Herkner founded his own studio. Since that time, he has designed furniture, lamps and smaller items for manufacturers such as Ames, and Tradition, Cappellini, ClassiCon, Dedon, Ex.t, Fontana Arte, Gubi, Linteloo, Moroso, Pulpo, Rosenthal, Schramm Werkstätten, Thonet, Wittmann and Zanotta. Herkner also realizes interior architecture projects and museum and exhibition design.

His works have won numerous accolades – among others the IF Award,

the Iconic Award and the Elle Deco International Design Award (EDIDA). As Guest of Honor to imm cologne 2016, Sebastian Herkner provided the design for “Das Haus”. Maison&Objet has elected him 2019 “Designer of the Year”.





# In conversation with STUDIO RODERICK VOS

---

趣玩设计 CP  
Curious and Playful Design Couple



Roderick 与 Claire Vos 1990 年毕业于埃因霍温设计学院。Roderick 本身就有亚洲血统，在日本工作期间对亚洲文化产生极大的兴趣，这段经历也对他的个人创作产生了很大的影响。Claire Vos 作为一名纺织品设计师，密切关注材质本身，热衷于重新诠释传统技术、色彩和形式。

1999 年，他们决定在荷兰赫斯登成立共同的设计室 Studio Roderick Vos，致力于创新的工作室主要从事灯饰、纺织品、配饰和家具设计，与 Driade、Moooli、Linteloo & Cor Unum 等众多国际品牌合作。

自 2016 年起，夫妇二人共同担任荷兰家具品牌 PODE 的艺术总监。他们设计的每件产品，都饱含他们对工艺技术、材料和颜色的精益求精。

Roderick and Claire Vos are both graduated in 1990 from the Academy of Industrial Design at Eindhoven's "Design Academy".

Being partly Asian himself, his working experience in Tokyo during 1987, as a trainee, evidently had a large impact on Roderick's personal interest in Asian Culture and his style in design. Production of textiles and ceramics has been in Claire Vos's family for generations. As a textile designer, Claire Vos specializes in re-interpreting traditional techniques, colorings and forms, paying close attention to the quality of the materials she uses.

In 1999 Claire & Roderick Vos officially started their design office 'Studio Roderick Vos', based in Heusden Vesting, the Netherlands. This innovative studio works mainly in lighting, textile, accessories and furniture design and has been cooperating with international brands such as Driade, Moooli, Linteloo & Cor Unum.

Since 2016 they both became art directors for Dutch furniture brand PODE. Each of their products is characterized by careful research and passion for technology, material and color.





# LIVING ROOM

---

客厅



Sofa 沙发 / BUFA 波波球    Coffee table 茶几 / FUNGHI 松露    Armchair 单人位 / BOL 元阳  
Side table 边几 / COSMO 星际







## BUFA 波波球

---

Yonoh

BUFA 沙发设计灵感来自充满趣味的气球，外形饱满圆润，视感富有弹性，靠背内外均采用缝线和褶皱细节处理，坐垫造型也以曲面呈现，没有一丝锐角，整体呈现复古摩登的怀旧风格。一盏复古质感的落地灯，沙发上随意的搭毯，伴随着悠扬的吉他和弦，感受时光的美好。

The BUFA sofa takes its name from the air balloons, the concept starts from designing a sofa with a large soft body where you can relax and unwind at home. BUFA is a fresh design, full of details and a soft look thanks to the volume, seams and folds of the material.





Sofa 沙发 / FIL 风尚 Coffee table 茶几 / CRI 可瑞 Armchair 单人位 / GIO 山谷  
Side table 边几 / ZEN 冰心 Living cabine 电视柜 / TRHYTHM 半岛











## FIL 风尚

---

### Yonoh

FIL 沙发系统，用平滑流畅的弧度勾画出饱满明朗的气度，用宽大的坐席让惬意蔓延。其标志型的靠背，可以高低结合，塑造出层次生动的轮廓，并以独特的宽榻围合出唯美优雅的空间。

Smooth and clean lines create a plump and bright style for FIL sofa. The wide seats are cozy. Its unique chaise builds an artistic space of elegance, and its signature back is composed of cushions with different heights, creating a vivid outline.

## CRI 可瑞

### Archirivolto Design

简洁精致的不锈钢底架，托起圆形桌面，并形成一个不锈钢围边，既和桌面嵌套又离开桌面互相呼应，这些精巧而新鲜的细节，让茶几气质脱俗，雅致好用。桌面可选木质或大理石。

A bright and sophisticated stainless steel frame supports the round top. The edge both covers the tabletop and sets it apart. These exquisite and creative details give this coffee table extraordinary charm. Not only it is elegant, but it is also thoughtful and useful. The top material can be either wood or marble.





HOUSE  
CENTURY  
STREET STORIES

LUXURY HOTELS  
CENTURY  
STREET STORIES



## GIO 山谷

---

Christophe Delcourt

GIO 单人沙发，用斜线和角度的语言展现出有力度的优雅，并通过精确的设计和做工，塑造了视觉的趣味和美感，看似轻松的几何态结构呈现了相当宜人的舒适感。

GIO armchair, a graceful furnishing, is built of diagonal lines and angles. The precise and neat design and spectacular craftwork make it a joy to behold. The geometric structure makes it fit comfortably in any contemporary room.



Sofa 沙发 / BERLIN 柏林    Coffee table 茶几 / GRASSI 格萨    Armchair 单人位 / CINI 旖旎    Cabinet 书柜 / STRATA 斯巴达  
Side table 边几 / STAGE 云台、CONE 科恩、MOON 尚月









# BERLIN 柏林

---

Sebastian Herkner

BERLIN 沙发的灵感来自于柏林的精神：可变性，永恒性和现代性，而这也正是这款组合沙发带给我们的惊喜。其简洁的曲线和比例，轻松舒适的坐感，形神兼备的细节，体现主人热情好客的态度。多变的组合模块，也可轻松适应户型与空间的大小。

BERLIN sofa is inspired by the spirit of the city: ever-changing, eternal and modern. The simplicity of its curves and proportions, cozy feeling and details connecting appearance with inner beauty altogether underline the generosity and hospitality from the host. Its changeable modules allow the piece to fit different spaces.

## CINI 旖旎

---

Dainelli Studio

CINI 单人位，承袭法国 18 世纪藤编围手椅的完美比例，以金属框架重塑经典，坐垫与靠背弧度勾勒出旖旎姿态，厚度填充饱满紧实，围合出亲近与欢迎感，并具备感染空间的表现力。

CINI single chair inherits the flawless proportion of the 18th-century rattan armchair with its metal frame and gorgeous curves of fully stuffed cushion and back. Intimacy can be felt in its hug. A space will be highlighted by the chair.







# STRATA 斯巴达

---

Studio Roderick Vos

STRATA 是一个充满硬核工业风的柜体系列。从明代设计与极简主义中汲取灵感，用现代设计语言书写出的柜体史诗，简洁中饱含力量，平仄间层次分明。利用工业技术实现手工工匠制造外观，高品质烤漆工艺，让柜体表面呈现出流动的光泽感，无须过多的外在修饰，就已足够利落硬朗。

STRATA collection contains a series of hardcore industrial-style cabinets. Its inspiration comes from Ming-Dynasty design and minimalism. Simple with power and clearly structured, the collection writes an epic of cabinet in a design language of today. Modern technology is applied to form the exterior which was used to be made by hand. High-end baking varnish adds fluid light on the surfaces. The cabinets speak for themselves with no need of extra decoration.



Sofa 沙发 / BARRY 百瑞 Coffee table 茶几 / CRI 可瑞 Armchair 单人位 / CALA 朵朵  
Side table 边几 / CONE 科恩、ZEN 冰心 Bookcase 书架 / UO 优沃

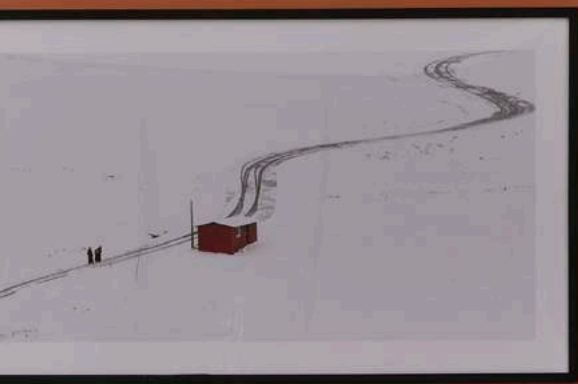

# BARRY 百瑞

---

Ximi Li 李希米

BARRY 沙发，内外高低的层叠双扶手设计，整体造型圆润柔和，给人双层的包裹感，既活跃又不浮夸，颇有“内衣外穿”的时尚表达。金属腿与金属条包边一气呵成，给人以年轻且时尚的视觉体验。

BARRY sofa's arms are composed of two layers of cushions of different heights. Wrapped in leather, contains two high and low tiers. The appearance looks soft, vivid and chic. The metal legs and edge are connected smoothly to create a young and stylish look.





Sofa 沙发 / UOVO 源    Coffee table 茶几 / UOVO 源  
Armchair 单人位 / UOVO 源    Side table 边几 / ZEN 冰心、UOVO 源





## UOVO 源

---

Steve Leung 梁志天

UOVO 系列的设计从美学到功能，从概念到工艺都展示着简约奢华的现代感。其纯熟自如的流线勾勒出高级的都会气息，转折，围合，绽放，收尾，都在充满节制感的曲线中呈现出最美的优雅。

UOVO collection is a combination of aesthetics and functionality. The contemporary and minimal design is characterized by its fluid and smooth lines created by the excellent craftsmanship, and it gives a sense of relaxation, elegance and personality to the collection.





# DINING ROOM

---

餐厅

Dining table 沙发 / GAUDI 高迪 Chair 茶几 / NAO 尼奥  
Wine cabinet 酒柜 / RITA 瑞达 Sideboard 边柜 / GRAPHIC 平川





# GAUDI 高迪

---

Archirivolto Design

高迪餐桌，从新哥特式风格建筑元素中汲取灵感，像一件结构感十足的雕塑作品。拱形金属底座，受到自然蜿蜒的曲线启示，优雅有序的簇拥在一起，承托着桌面，在曲面折射的光影变化中，散发着迷人的生命力。

The sculpture-like GAUDI dining table draws inspiration from neo-gothic architecture. The idea of arching metal base comes from curves in nature. They stand together gracefully to prop up the table. Light is refracted vigorously on the curved surfaces.





Dining table 餐桌 / SIFF 江月    Chair 椅子 / BOLA 飞燕  
Sideboard 边柜 / GRU 律动









## SIFF 江月

Christophe Delcourt

SIFF 餐桌通透、灵动，充满未来的现代感，桌腿结构以“半圆展翅”的形态，托举着延伸感的玻璃桌面，木质的柱体与灰色玻璃的轻透，更是虚实有致，充满了构成般的画面感。

SIFF is a transparent dining table that is futuristic and contemporary. Its legs are semi-round and stretch like wings lifting the glass top. The dark wood pillar lifts up the light gray glass for a light and sturdy structure that is well composed.



Dining table 餐桌 / GRID 格韵    Chair 椅子 / MELLOW 云端    Sideboard 边柜 / LEVHIA 璃影  
Wine cabinet 酒柜 / RITA 瑞达







# GRID 格韵

---

Ximi Li 李希米

GRID 餐桌是一件充满艺术感的设计作品。曲线消失，垂直与水平结构成为主导地位，虚实相应的格子排列出韵味，呈现出优雅的节奏感。金属与岩板的搭配赋予餐桌冷峻的个性。

The eye-catching GRID Dining Table is an art in your dining room. It offers slim and sleek silhouette, creates strong light and shadows without a single curve line.

# MELLOW 云端

---

Ximi Li 李希米

MELLOW 云端系列灵感来自层叠错落的云朵，设计师巧妙利用设计语言将其重新解构，靠背前后层次错落，演绎出体块堆叠的建筑感效果。外层靠背呈半弧状，增加了背部的支撑与包裹感。

MELLOW collection is inspired by layered clouds. It gently hugs you with its whimsical and layered back. The tubular metal legs adds a polish touch to the design.







## LEVHIA 璃影

Dainelli Studio

LEVHIA 玻璃外框与木盒构建出似有还无的结构，呈现出如光影般的透视感，大容量储物格，满足红酒与餐具的收纳，让储物空间精致有序。

LEVHIA cabinet offers an airy and frameless aesthetic. The transparent glass catches light and create shadows while drawers still contain generous storage room for wine and utensils.



# BEDROOM

---

卧室



Bed 床 / MELLOW 云端    Bedside table 床头柜 / HOOP 霍普、PLUS 佳怡    Cabinet 柜子 / BELLA 贝拉  
Stool 坐墩 / PRISMA 万象    Console 条案 / MOON 尚月









# MELLOW 云端

---

Ximi Li 李希米

MELLOW 云端系列灵感来自层叠错落的云朵，设计师巧妙利用设计语言将其重新解构，床头靠背前后层次错落，内层衬板像屏风一般延伸至地面，包覆式设计的体量感与金属底脚的轻盈形成鲜明对比，使睡床成为卧室中的一大亮点。

MELLOW collection is inspired by layed clouds. It gently hugs you with its whimsical and layered back. The tubular metal legs adds a polish touch to the design.



Bed 床 / BARRY 百瑞   Sofa 沙发 / BARRY 百瑞  
Side table 边几 / TILE 泰然、PLUS 佳怡   Bookcase 书架 / UO 优沃









## BARRY 百瑞

---

Ximi Li 李希米

BARRY 床，透出精致的绅士气息，皮质包角，营造高低的内外层叠效果，整体造型圆润柔和，给人双层的包裹感，既活跃又不浮夸，颇有“内衣外穿”的时尚表达。金属腿与金属条包边一气呵成，给人以年轻且时尚的视觉体验。

BARRY collection composed of two layers of cushions of different heights. Wrapped in leather, the head of BARRY bed also contains two high and low tiers. The appearance looks soft, vivid and chic. The metal legs and edge are connected smoothly to create a young and stylish look.

UO 优沃

---

Hi Thanks Bye

不规则的搁架设计，带给人不一样的视觉冲击力，个性十足。“窗口”和“夹心”的位置都有放置物品的不同方式，UO 透过每个窗口与外界进行对话，也将内部的收纳调理出趣味。外向，内向，都是向美而生。

The irregular shelves create a special visual effect. People can store stuffs on the 'window' and 'hollow' in different ways. UO bookcase speaks to the world through each window with fun. Various types of beauty can be felt.



Bed 床 / UOVO 源    Bedside Table 床头柜 / ANNI 悠然  
Armchair 单人位 / UOVO 源    Desk 书桌 / LARGO 罗曼







## UOVO 源

---

Steve Leung 梁志天

UOVO 床，用流畅的曲线勾勒出最舒适的弧度，转折，围合，绽放和收尾都在可控的曲线中，展现低调奢华的气质，并给卧室一份雅致的格调。

UOVO bed uses gentle and smooth curves to evoke the feeling of sanctuary. The subtle and comfortable form embody artistry and it sets the tone of a bedroom with understated luxury.





# PRODUCT INDEX

---

## 产品目录

沙发 SOFA	88-109
单人位 ARMCHAIR	110-113
茶几 COFFEE TABLE	114-117
边几 SIDE TABLE	118-120
条案 CONSOLE	121
电视柜 LIVING CABINET	122-125
餐桌 DINING TABLE	126-129
椅子 CHAIR	130-133
餐边柜 SIDEBOARD	134-135
床 & 床头柜 BED & BEDSIDE TABLE	136-141
书桌 & 书架 DESK & BOOK CASE	142-143
配饰 ACCESSORY	144
地毯 RUG	145

# SOFA

沙发

---



**BOL** 元阳  
Christophe Delcourt



尺寸: 2250\*835\*632mm  
2000\*835\*632mm  
1020\*835\*632mm  
编号: 31F004

---

产品描述: 沙发整体为布料, 底框与底脚为实木开孔漆

PRODUCT DESCRIPTION: Upholstered with fabric. Frame and feet in solid wood

## BARRY 百瑞

Ximi Li 李希米



尺寸: 2300\*850\*770mm  
编号: 31F019

**产品描述:** 沙发外侧为牛皮包制, 其他部分可选择面料或与外侧同色牛皮。底脚为黑灰氟碳漆金属

**PRODUCT DESCRIPTION:** Upholstered with fabric or leather, outside of the armrest and back in leather only. Metal feet in dark grey epoxy paint finish

## NEST 巢

Studio Roderick Vos



尺寸: 1160\*912\*720mm  
1960\*912\*720mm  
2360\*912\*720mm  
编号: 31F014

**产品描述:** 沙发整体为 Marshmallow 系列布料包制, 底脚为黑色烤漆金属

**PRODUCT DESCRIPTION:** Upholstered with fabric from the Marshmallow collection. Metal feet in black lacquer finish

## CORE 相拥

Siyu Chen (CAFA) 央美陈思雨



尺寸: 2000\*866\*735mm  
1800\*866\*735mm  
编号: 31F025

**产品描述:** 沙发整体为布料包制, 底脚为黑灰氟碳漆金属

**PRODUCT DESCRIPTION:** Upholstered with fabric. Metal feet in dark grey epoxy paint

# BUFA 波波球

Yonoh



编号: 31F022

产品描述: 沙发整体为 Noah 系列布料包制, 底脚为黑丝光烤漆金属

PRODUCT DESCRIPTION: Upholstered with fabric from the Noah collection. Metal feet in black satin finish

## 沙发 SOFA

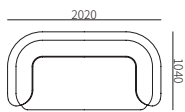

尺寸: 2020\*1040\*710mm  
编码: 31F022-12

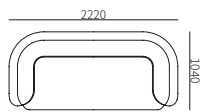

尺寸: 2220\*1040\*710mm  
编码: 31F022-13

## 单扶 LEFT/RIGHT ONE-ARMED SOFA

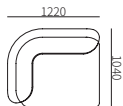

尺寸: 1220\*1040\*710mm  
编码: 31F022-20

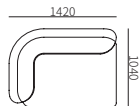

尺寸: 1420\*1040\*710mm  
编码: 31F022-21

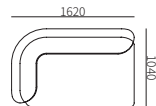

尺寸: 1620\*1040\*710mm  
编码: 31F022-22

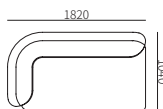

尺寸: 1820\*1040\*710mm  
编码: 31F022-23

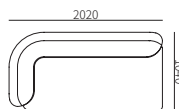

尺寸: 2020\*1040\*710mm  
编码: 31F022-24

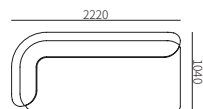

尺寸: 2220\*1040\*710mm  
编码: 31F022-25

## 单背 SOFA WITHOUT ARM

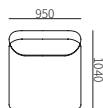

尺寸: 950\*1040\*710mm  
编码: 31F022-30

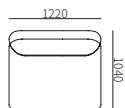

尺寸: 1220\*1040\*710mm  
编码: 31F022-31

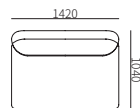

尺寸: 1420\*1040\*710mm  
编码: 31F022-32

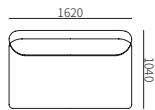

尺寸: 1620\*1040\*710mm  
编码: 31F022-33

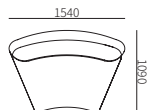

尺寸: 1540\*1090\*710mm  
编码: 31F022-71



转角 LEFT/RIGHT CHAISE

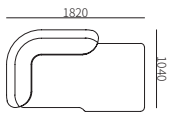

尺寸: 1820\*1040\*710mm  
编码: 31F022-42

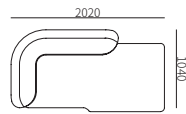

尺寸: 2020\*1040\*710mm  
编码: 31F022-43

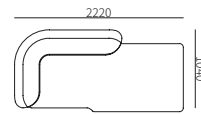

尺寸: 2220\*1040\*710mm  
编码: 31F022-44

塌 OTTOMAN

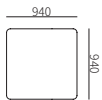

尺寸: 940\*940\*390mm  
编码: 31F022-51

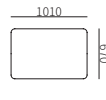

尺寸: 1010\*670\*390mm  
编码: 31F022-52

角位 LEFT/RIGHT CORNER SEAT

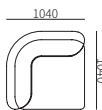

尺寸: 1040\*1040\*710mm  
编码: 31F022-61

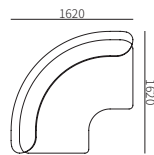

尺寸: 1620\*1620\*710mm  
编码: 31F022-62

组合沙发 SECTIONAL SOFA

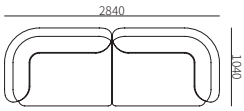

尺寸: 2840\*1040\*710mm

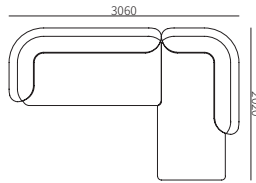

尺寸: 3060\*2020\*710mm

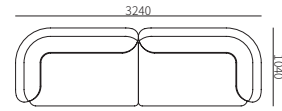

尺寸: 3240\*1040\*710mm

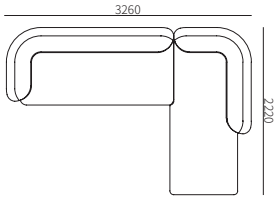

尺寸: 3260\*2220\*710mm

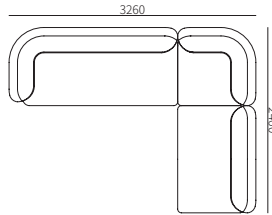

尺寸: 3260\*2460\*710mm

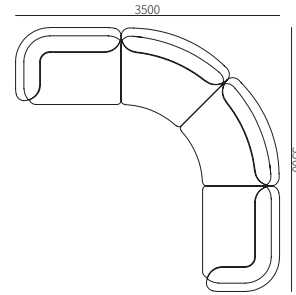

尺寸: 3500\*3500\*710mm

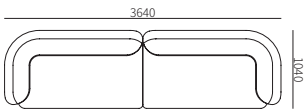

尺寸: 3260\*2220\*710mm

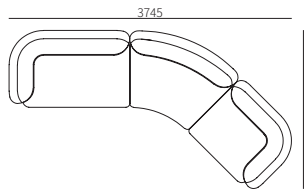

尺寸: 3745\*2100\*710mm

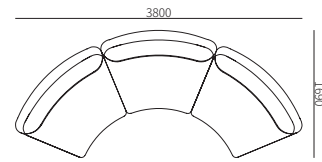

尺寸: 3800\*1690\*710mm

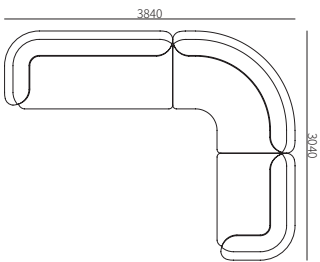

尺寸: 3840\*3040\*710mm

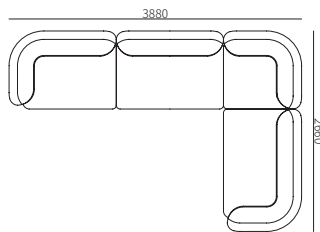

尺寸: 3880\*2660\*710mm

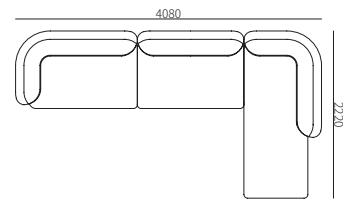

尺寸: 4080\*2220\*710mm

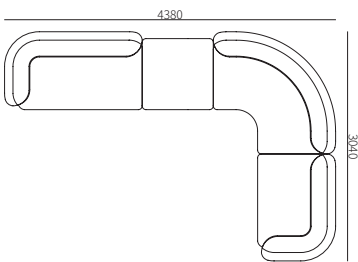

尺寸: 4380\*3040\*710mm

# MELLOW 云端

Ximi Li 李希米



编号: 31F024

产品描述: 沙发整体为布料或牛皮包制, 底脚为黑丝光烤漆金属

PRODUCT DESCRIPTION: Upholstered with fabric or leather. Metal feet in black satin finish

## 沙发 SOFA

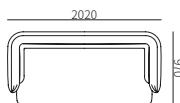

尺寸: 2020\*970\*770mm  
编码: 31F024-12

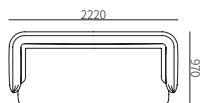

尺寸: 2220\*970\*770mm  
编码: 31F024-13

## 单扶 LEFT/RIGHT ONE-ARMED SOFA

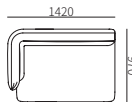

尺寸: 1420\*970\*770mm  
编码: 31F024-21

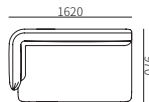

尺寸: 1620\*970\*770mm  
编码: 31F024-22

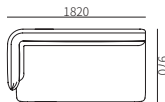

尺寸: 1820\*970\*770mm  
编码: 31F024-23

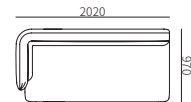

尺寸: 2020\*970\*770mm  
编码: 31F024-24

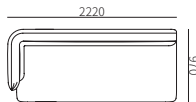

尺寸: 2220\*970\*770mm  
编码: 31F024-25

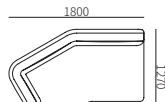

尺寸: 1800\*1270\*770mm  
编码: 31F024-26

## 单背 SOFA WITHOUT ARM

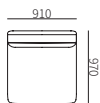

尺寸: 910\*970\*770mm  
编码: 31F024-31

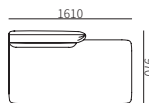

尺寸: 1610\*970\*770mm  
编码: 31F024-71

## 转角 LEFT/RIGHT CHAISE

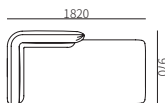

尺寸: 1820\*970\*770mm  
编码: 31F024-41

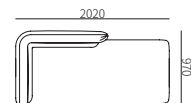

尺寸: 2020\*970\*770mm  
编码: 31F024-42

## 塌 OTTOMAN

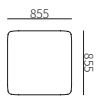

尺寸: 855\*855\*400mm  
编码: 31F024-51

## 角位 LEFT/RIGHT CORNER SEAT

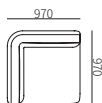

尺寸: 970\*970\*770mm  
编码: 31F024-61

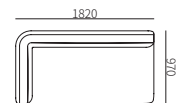

尺寸: 1820\*970\*770mm  
编码: 31F024-62

组合沙发 SECTIONAL SOFA

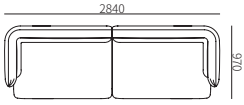

尺寸: 2840\*970\*770mm

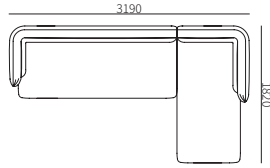

尺寸: 3190\*1820\*770mm

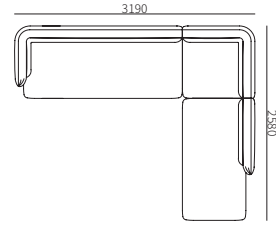

尺寸: 3190\*2580\*770mm

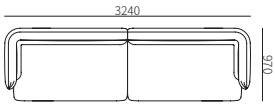

尺寸: 3240\*970\*770mm

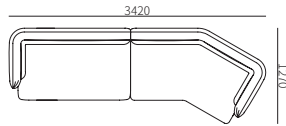

尺寸: 3420\*1270\*770mm

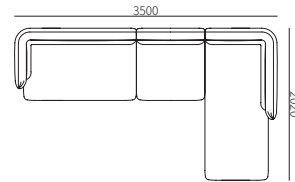

尺寸: 3500\*2020\*770mm

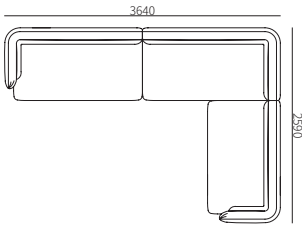

尺寸: 3640\*2590\*770mm

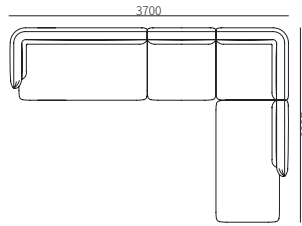

尺寸: 3700\*2580\*770mm

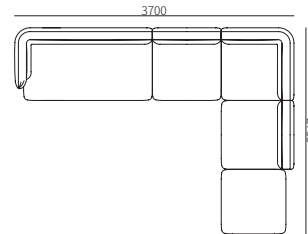

尺寸: 3700\*2735\*770mm

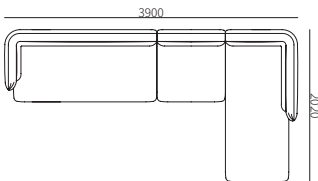

尺寸: 3900\*2020\*770mm

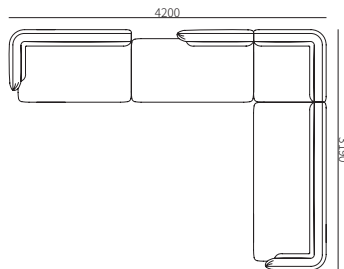

尺寸: 4200\*3190\*770mm



---

CÔTE D' AZUR 蓝色海岸  
L&L Studio



编号: 31F023

产品描述: 沙发整体为布料或牛皮包制, 底腿为黑灰氟碳漆金属

PRODUCT DESCRIPTION: Upholstered with fabric or leather. Metal feet in dark grey epoxy paint

沙发 SOFA

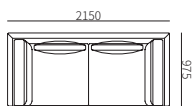

尺寸: 2150\*975\*740mm  
编码: 31F023-12

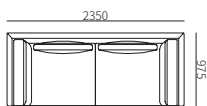

尺寸: 2350\*975\*740mm  
编码: 31F023-13

单扶 LEFT/RIGHT ONE-ARMED SOFA

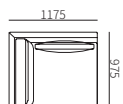

尺寸: 1175\*975\*740mm  
编码: 31F023-21

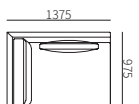

尺寸: 1375\*975\*740mm  
编码: 31F023-22

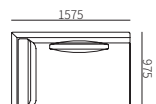

尺寸: 1575\*975\*740mm  
编码: 31F023-23

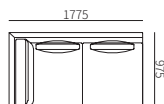

尺寸: 1775\*975\*740mm  
编码: 31F023-24

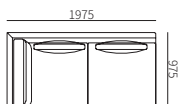

尺寸: 1975\*975\*740mm  
编码: 31F023-25

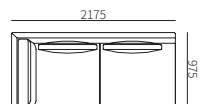

尺寸: 2175\*975\*740mm  
编码: 31F023-26

单背 SOFA WITHOUT ARM

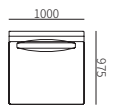

尺寸: 1000\*975\*740mm  
编码: 31F023-31

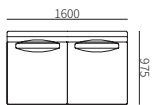

尺寸: 1600\*975\*740mm  
编码: 31F023-32

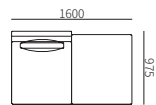

尺寸: 1600\*975\*740mm  
编码: 31F023-71

转角 LEFT/RIGHT CHAISE

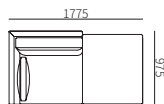

尺寸: 1775\*975\*740mm  
编码: 31F023-41

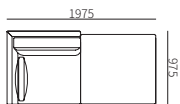

尺寸: 1975\*975\*740mm  
编码: 31F023-42

塌 OTTOMAN

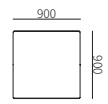

尺寸: 900\*900\*420mm  
编码: 31F023-51

角位 LEFT/RIGHT CORNER SEAT

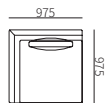

尺寸: 975\*975\*740mm  
编码: 31F023-61

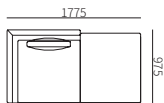

尺寸: 1775\*975\*740mm  
编码: 31F023-62

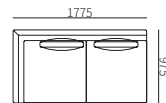

尺寸: 1775\*975\*740mm  
编码: 31F023-63

沙发 SOFA

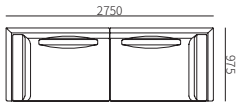

尺寸：2750\*975\*740mm

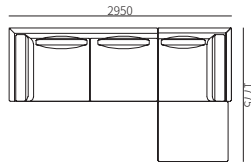

尺寸：2950\*1775\*740mm

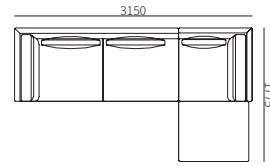

尺寸：3150\*1775\*740mm

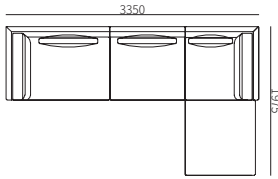

尺寸：3350\*1975\*740mm

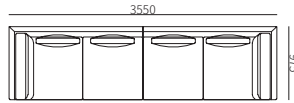

尺寸：3550\*975\*740mm

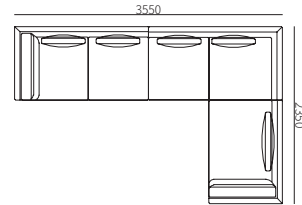

尺寸：3550\*2350\*740mm

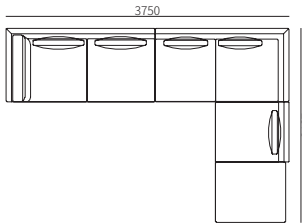

尺寸：3750\*2575\*740mm

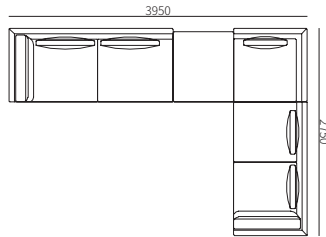

尺寸：3950\*2750\*740mm



编号: 31F006

产品描述: 沙发整体为布料或牛皮包制, 底部为黑色烤漆金属

PRODUCT DESCRIPTION: Upholstered with fabric or leather. Metal feet in black lacquer finish

沙发 SOFA

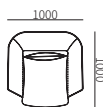

尺寸: 1000\*1000\*755mm  
编码: 31F006-11

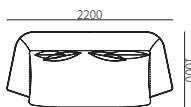

尺寸: 2200\*1000\*755mm  
编码: 31F006-12

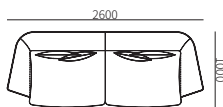

尺寸: 2600\*1000\*755mm  
编码: 31F006-13

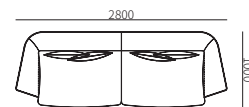

尺寸: 2800\*1000\*755mm  
编码: 31F006-14

单扶 LEFT/RIGHT ONE-ARMED SOFA

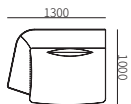

尺寸: 1300\*1000\*755mm  
编码: 31F006-21

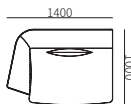

尺寸: 1400\*1000\*755mm  
编码: 31F006-22

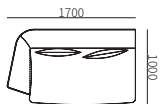

尺寸: 1700\*1000\*755mm  
编码: 31F006-23

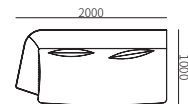

尺寸: 2000\*1000\*755mm  
编码: 31F006-24

单背 SOFA WITHOUT ARM

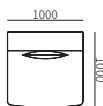

尺寸: 1000\*1000\*755mm  
编码: 31F006-31

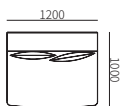

尺寸: 1200\*1000\*755mm  
编码: 31F006-32

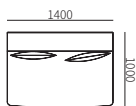

尺寸: 1400\*1000\*755mm  
编码: 31F006-33

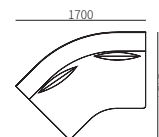

尺寸: 1700\*1414\*755mm  
编码: 31F006-34

转角 LEFT/RIGHT CHAISE

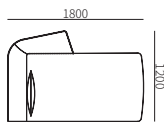

尺寸: 1800\*1200\*755mm  
编码: 31F006-41

角位 LEFT/RIGHT CORNER SEAT

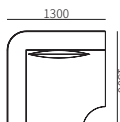

尺寸: 1300\*1300\*755mm  
编码: 31F006-61



组合沙发 SECTIONAL SOFA

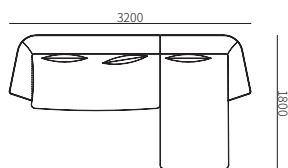

尺寸: 3200\*1800\*755mm  
编码: 31F006ZH-01

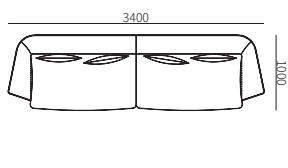

尺寸: 3400\*1000\*755mm  
编码: 31F006ZH-02

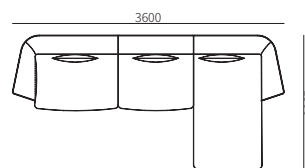

尺寸: 3600\*1800\*755mm  
编码: 31F006ZH-03

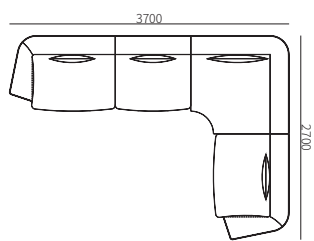

尺寸: 3700\*2700\*755mm  
编码: 31F006ZH-04

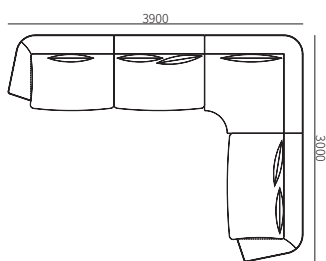

尺寸: 3900\*3000\*755mm  
编码: 31F006ZH-05

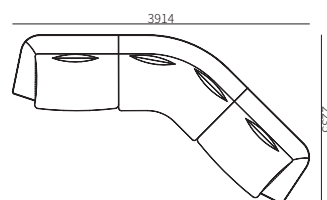

尺寸: 3914\*2235\*755mm  
编码: 31F006ZH-06

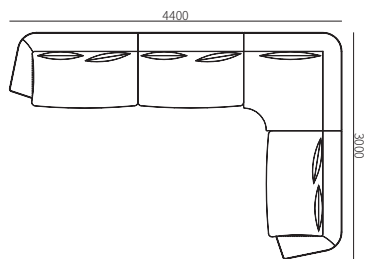

尺寸: 4400\*3000\*755mm  
编码: 31F006ZH-07

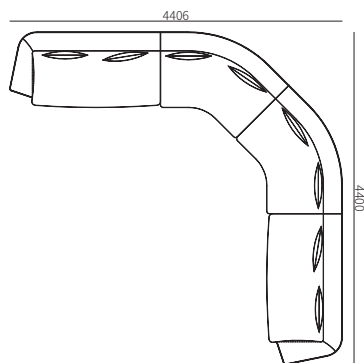

尺寸: 4406\*4400\*755mm  
编码: 31F006ZH-08

**FIL 风尚**  
Yonoh



编号: 31F011

产品描述: 沙发整体为布料或牛皮包制, 底部为黑丝光烤漆金属

PRODUCT DESCRIPTION: Upholstered with fabric or leather. Metal feet in black satin finish

沙发 SOFA

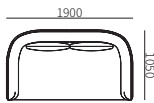

尺寸: 1900\*1050\*680mm  
编码: 31F011-12

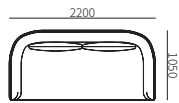

尺寸: 2200\*1050\*680mm  
编码: 31F011-13

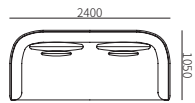

尺寸: 2400\*1050\*680mm  
编码: 31F011-14

单扶 LEFT/RIGHT ONE-ARMED SOFA

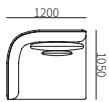

尺寸: 1200\*1050\*680mm  
编码: 31F011-24

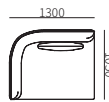

尺寸: 1300\*1050\*680mm  
编码: 31F011-20

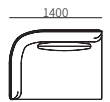

尺寸: 1400\*1050\*680mm  
编码: 31F011-21

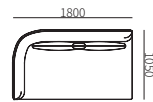

尺寸: 1800\*1050\*680mm  
编码: 31F011-22

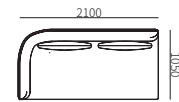

尺寸: 2100\*1050\*680mm  
编码: 31F011-23

单背 SOFA WITHOUT ARM

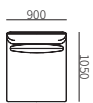

尺寸: 900\*1050\*680mm  
编码: 31F011-31

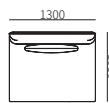

尺寸: 1300\*1050\*680mm  
编码: 31F011-32

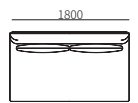

尺寸: 1800\*1050\*680mm  
编码: 31F011-33

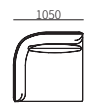

尺寸: 1050\*1050\*680mm  
编码: 31F011-61

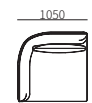

尺寸: 1050\*1050\*880mm  
编码: 31F011-62

角位 LEFT/RIGHT CORNER SEAT

转角 LEFT/RIGHT CHAISE

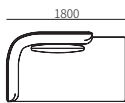

尺寸: 1800\*1050\*680mm  
编码: 31F011-41

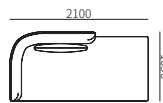

尺寸: 2100\*1050\*680mm  
编码: 31F011-42

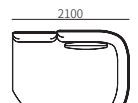

尺寸: 2100\*1800\*880mm  
编码: 31F011-63



尺寸: 1700\*1500\*880mm  
编码: 31F011-64

墩 OTTOMAN

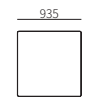

尺寸: 935\*935\*400mm  
编码: 31F011-51



组合沙发 SECTIONAL SOFA

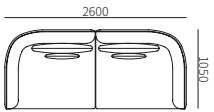

尺寸: 2600\*1050\*680mm  
编码: 31F011ZH-09

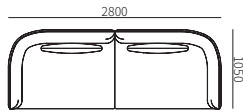

尺寸: 2800\*1050\*680mm  
编码: 31F011ZH-01

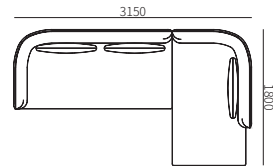

尺寸: 3150\*1800\*680mm  
编码: 31F011ZH-02

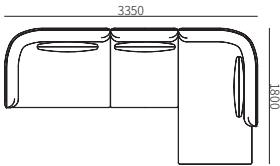

尺寸: 3350\*1800\*680mm  
编码: 31F011ZH-03

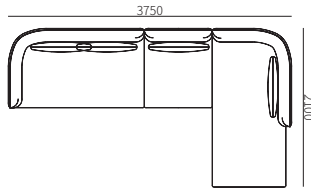

尺寸: 3750\*2100\*680mm  
编码: 31F011ZH-04

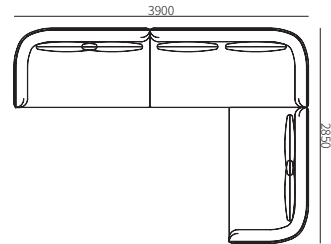

尺寸: 3900\*2850\*680mm  
编码: 31F011ZH-05

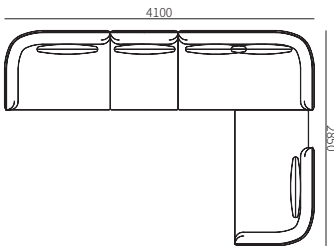

尺寸: 4100\*2850\*680mm  
编码: 31F011ZH-06

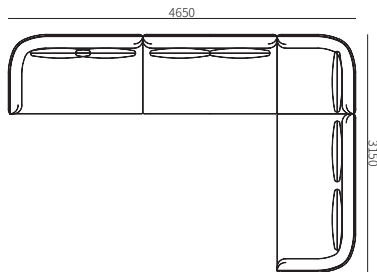

尺寸: 4650\*3150\*680mm  
编码: 31F011ZH-07

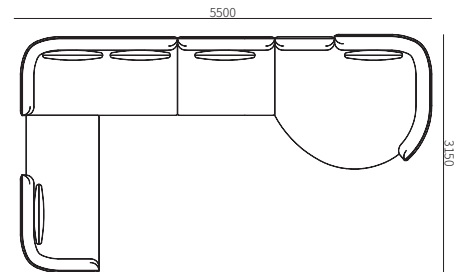

尺寸: 5500\*3150\*880mm  
编码: 31F011ZH-08

# BERLIN 柏林

Sebastian Herkner



编号: 31F016

产品描述: 沙发整体为布料或牛皮包制, 底脚为黑丝光烤漆金属。沙发套可拆洗, 需干洗

PRODUCT DESCRIPTION: Upholstered with fabric or leather. Metal feet in black satin finish. Slipcovers can be removed for dry cleaning

## 沙发 SOFA

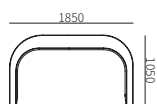

尺寸: 1850\*1050\*680mm  
编码: 31F016-12

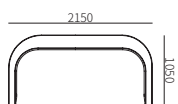

尺寸: 2150\*1050\*680mm  
编码: 31F016-13

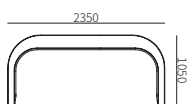

尺寸: 2350\*1050\*680mm  
编码: 31F016-14

## 单扶 LEFT/RIGHT ONE-ARMED SOFA

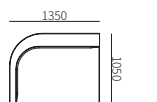

尺寸: 1350\*1050\*680mm  
编码: 31F016-21

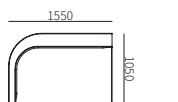

尺寸: 1550\*1050\*680mm  
编码: 31F016-22

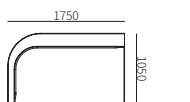

尺寸: 1750\*1050\*680mm  
编码: 31F016-23

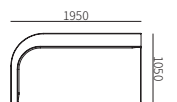

尺寸: 1950\*1050\*680mm  
编码: 31F016-24

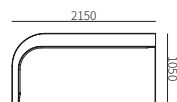

尺寸: 2150\*1050\*680mm  
编码: 31F016-25

## 单背 SOFA WITHOUT ARM

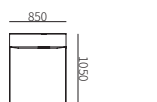

尺寸: 850\*1050\*680mm  
编码: 31F016-31

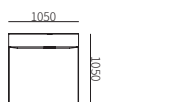

尺寸: 1050\*1050\*680mm  
编码: 31F016-32

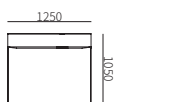

尺寸: 1250\*1050\*680mm  
编码: 31F016-33

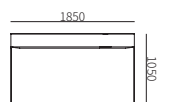

尺寸: 1850\*1050\*680mm  
编码: 31F016-34

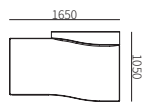

尺寸: 1650\*1050\*680mm  
编码: 31F016-71

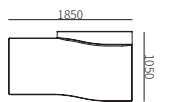

尺寸: 1850\*1050\*680mm  
编码: 31F016-72

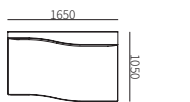

尺寸: 1650\*1050\*680mm  
编码: 31F016-73

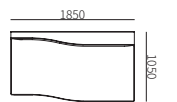

尺寸: 1850\*1050\*680mm  
编码: 31F016-74

## 转角 LEFT/RIGHT CHAISE

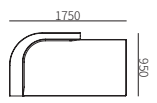

尺寸: 1750\*950\*680mm  
编码: 31F016-41

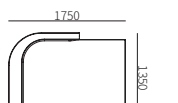

尺寸: 1750\*1350\*680mm  
编码: 31F016-42

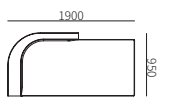

尺寸: 1900\*950\*680mm  
编码: 31F016-43

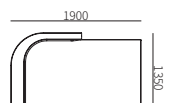

尺寸: 1900\*1350\*680mm  
编码: 31F016-44





榻 OTTOMAN

角位 LEFT/RIGHT CORNER SEAT



尺寸: 850\*950\*400mm  
编码: 31F016-51



尺寸: 850\*1050\*400mm  
编码: 31F016-52



尺寸: 950\*1050\*680mm  
编码: 31F016-61

组合沙发 SECTIONAL SOFA

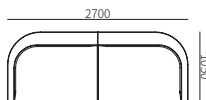

尺寸: 2700\*1050\*680mm  
编码: 31F016ZH-01

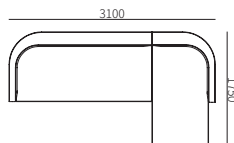

尺寸: 3100\*1750\*680mm  
编码: 31F016ZH-02

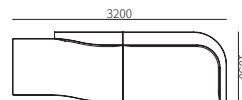

尺寸: 3200\*1050\*680mm  
编码: 31F016ZH-03

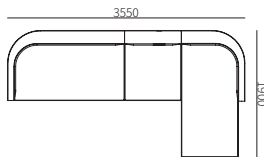

尺寸: 3550\*1900\*680mm  
编码: 31F016ZH-04

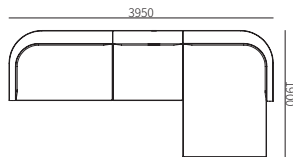

尺寸: 3950\*1900\*680mm  
编码: 31F016ZH-05

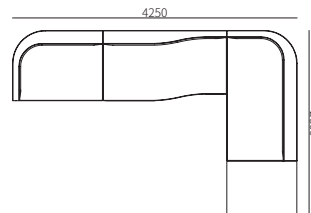

尺寸: 4250\*2800\*680mm  
编码: 31F016ZH-06

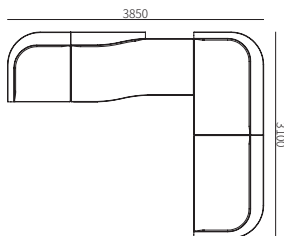

尺寸: 3850\*3100\*680mm  
编码: 31F016ZH-07

# MICHEL 米其

Yonoh



编号: 31F009 / 31F015

**产品描述:** 31F009: 沙发整体为布料或牛皮包制, 脚为黑丝光烤漆金属。  
31F015: 沙发主体为牛皮包制, 坐垫与靠包为布料包制, 脚为黑丝光烤漆金属 (皮布结合款)

**PRODUCT DESCRIPTION:** 31F009: Upholstered with fabric or leather. Metal feet in black satin finish. 31F015: Upholstered with leather, cushions in fabric. Metal feet in black satin finish

## 沙发 SOFA

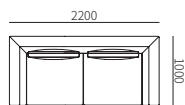

尺寸: 2200\*1000\*680mm  
编码: 31F009 / 31F015-13

## 单扶 LEFT/RIGHT ONE-ARMED SOFA

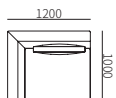

尺寸: 1200\*1000\*680mm  
编码: 31F009 / 31F015-21

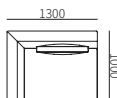

尺寸: 1300\*1000\*680mm  
编码: 31F009 / 31F015-20

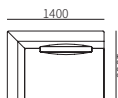

尺寸: 1400\*1000\*680mm  
编码: 31F009 / 31F015-22

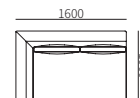

尺寸: 1600\*1000\*680mm  
编码: 31F009 / 31F015-23

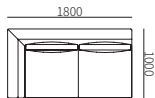

尺寸: 1800\*1000\*680mm  
编码: 31F009 / 31F015-24

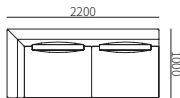

尺寸: 2200\*1000\*680mm  
编码: 31F009 / 31F015-25

## 单背 SOFA WITHOUT ARM

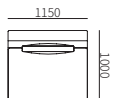

尺寸: 1150\*1000\*680mm  
编码: 31F009 / 31F015-31



尺寸: 1350\*1000\*680mm  
编码: 31F009 / 31F015-32

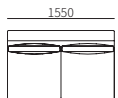

尺寸: 1550\*1000\*680mm  
编码: 31F009 / 31F015-33

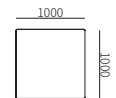

尺寸: 1000\*1000\*400mm  
编码: 31F009 / 31F015-51

## 转角 LEFT/RIGHT CHAISE

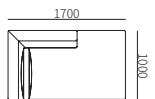

尺寸: 1700\*1000\*680mm  
编码: 31F009 / 31F015-41

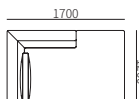

尺寸: 1700\*1200\*680mm  
编码: 31F009 / 31F015-42

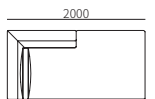

尺寸: 2000\*1000\*680mm  
编码: 31F009 / 31F015-43

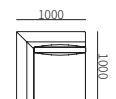

尺寸: 1000\*1000\*680mm  
编码: 31F009 / 31F015-61

## 角位 LEFT/RIGHT CORNER SEAT



组合沙发 SECTIONAL SOFA

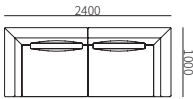

尺寸：2400\*1000\*680mm  
编码：31F009ZH / 31F015ZH-01

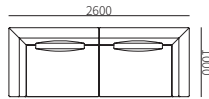

尺寸：2600\*1000\*680mm  
编码：31F009ZH / 31F015ZH-10

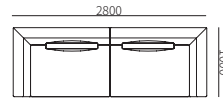

尺寸：2800\*1000\*680mm  
编码：31F009ZH / 31F015ZH-02

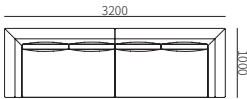

尺寸：3200\*1000\*680mm  
编码：31F009ZH / 31F015ZH-03

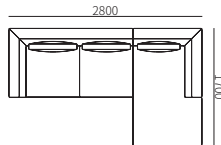

尺寸：2800\*1700\*680mm  
编码：31F009ZH / 31F015ZH-04

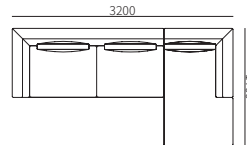

尺寸：3200\*1700\*680mm  
编码：31F009ZH / 31F015ZH-05

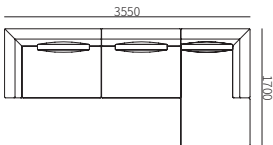

尺寸：3550\*1700\*680mm  
编码：31F009ZH / 31F015ZH-06

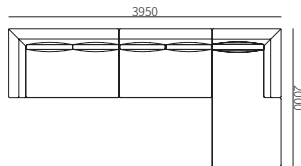

尺寸：3950\*2000\*680mm  
编码：31F009ZH / 31F015ZH-07

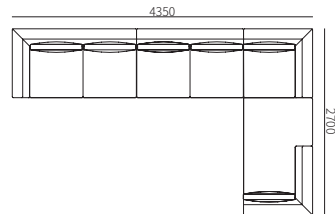

尺寸：4350\*2700\*680mm  
编码：31F009ZH / 31F015ZH-08

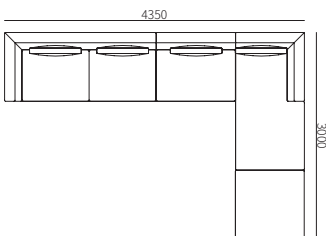

尺寸：4350\*3000\*680mm  
编码：31F009ZH / 31F015ZH-09

# SHELL 沃野

Frank Chou 周宸宸



编号: 31F017

**产品描述:** 沙发靠背与底座框为牛皮包制, 扶手与坐垫可选择布料或与靠背, 底座框同色牛皮。底脚为黑灰氟碳漆金属。底框不可拆洗, 其他部分可拆洗, 需干洗

**PRODUCT DESCRIPTION:** Upholstered with fabric or leather, sofa back and bottom are upholstered in leather only. Metal feet in dark grey epoxy paint finish. Slipcovers (except for bottom frame) can be removed for dry cleaning

## 沙发 SOFA

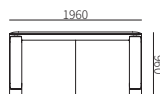

尺寸: 1960\*960\*690mm  
编码: 31F017-12

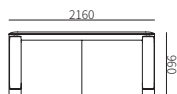

尺寸: 2160\*960\*690mm  
编码: 31F017-13

## 单扶 LEFT/RIGHT ONE-ARMED SOFA

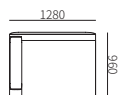

尺寸: 1280\*960\*690mm  
编码: 31F017-21

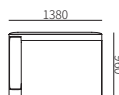

尺寸: 1380\*960\*690mm  
编码: 31F017-22

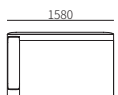

尺寸: 1580\*960\*690mm  
编码: 31F017-23

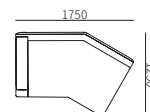

尺寸: 1750\*1250\*690mm  
编码: 31F017-24

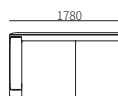

尺寸: 1780\*960\*690mm  
编码: 31F017-25

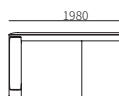

尺寸: 1980\*960\*690mm  
编码: 31F017-26

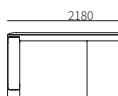

尺寸: 2180\*960\*690mm  
编码: 31F017-27

## 单背 SOFA WITHOUT ARM



尺寸: 900\*960\*690mm  
编码: 31F017-31



尺寸: 1000\*960\*690mm  
编码: 31F017-32

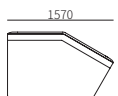

尺寸: 1570\*1250\*690mm  
编码: 31F017-33

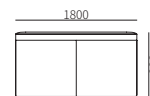

尺寸: 1800\*960\*690mm  
编码: 31F017-34

## 转角 LEFT/RIGHT CHAISE

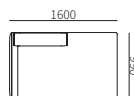

尺寸: 1600\*990\*690mm  
编码: 31F017-41

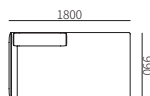

尺寸: 1800\*990\*690mm  
编码: 31F017-42

## 榻 OTTOMAN



尺寸: 840\*840\*380mm  
编码: 31F017-51



角位 LEFT/RIGHT CORNER SEAT



尺寸: 960\*960\*690mm  
编码: 31F017-61

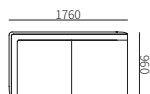

尺寸: 1760\*960\*690mm  
编码: 31F017-62

组合沙发 SECTIONAL SOFA

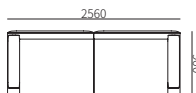

尺寸: 2560\*960\*690mm  
编码: 31F017ZH-1

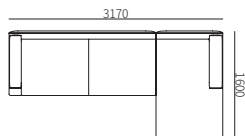

尺寸: 3170\*1600\*690mm  
编码: 31F017ZH-2

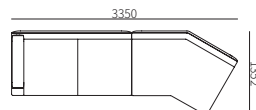

尺寸: 3350\*1352\*690mm  
编码: 31F017ZH-3

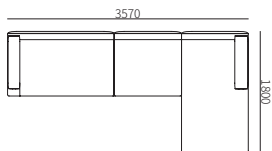

尺寸: 3570\*1800\*690mm  
编码: 31F017ZH-4

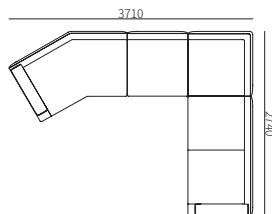

尺寸: 3710\*2740\*690mm  
编码: 31F017ZH-5

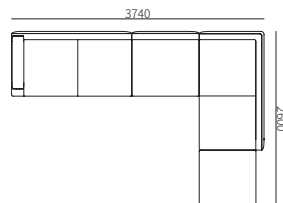

尺寸: 3740\*2600\*690mm  
编码: 31F017ZH-6

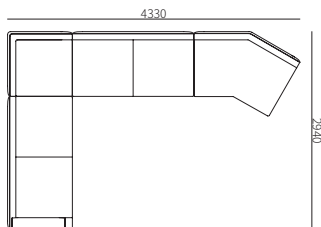

尺寸: 4330\*2940\*690mm  
编码: 31F017ZH-7

# QUADRA 嘉里

Yonoh



编号: 31F008

产品描述: 沙发整体为布料或牛皮包制, 沙发套可拆洗, 需干洗。底框及底脚为黑镜镀钛不锈钢。可添加木制开孔漆储物盒

PRODUCT DESCRIPTION: Upholstered with fabric or leather. Slipcovers can be removed for dry cleaning. Stainless steel frame and feet in black titanium plating. Storage cabinet add on is optional

## 沙发 SOFA



尺寸: 720\*730\*640mm  
编码: 31F008-11

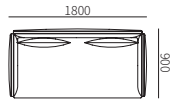

尺寸: 1800\*900\*780mm  
编码: 31F008-12

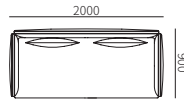

尺寸: 2000\*900\*780mm  
编码: 31F008-13

## 单扶 LEFT/RIGHT ONE-ARMED SOFA

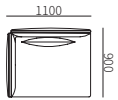

尺寸: 1100\*900\*780mm  
编码: 31F008-21

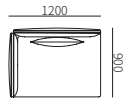

尺寸: 1200\*900\*780mm  
编码: 31F008-22

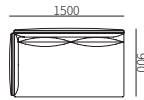

尺寸: 1500\*900\*780mm  
编码: 31F008-23

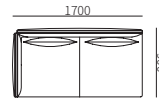

尺寸: 1700\*900\*780mm  
编码: 31F008-24

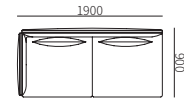

尺寸: 1900\*900\*780mm  
编码: 31F008-25

## 单背 SOFA WITHOUT ARM

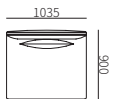

尺寸: 1035\*900\*780mm  
编码: 31F008-31

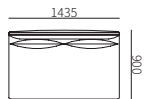

尺寸: 1435\*900\*780mm  
编码: 31F008-32

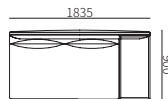

尺寸: 1835\*900\*780mm  
编码: 31F008-33

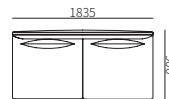

尺寸: 1835\*900\*780mm  
编码: 31F008-34

## 角位 LEFT/RIGHT CORNER SEAT

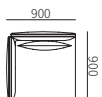

尺寸: 900\*900\*780mm  
编码: 31F008-61

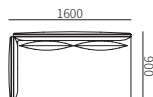

尺寸: 1600\*900\*780mm  
编码: 31F008-62

## 转角 LEFT/RIGHT CHAISE

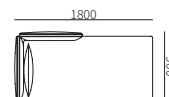

尺寸: 1800\*900\*780mm  
编码: 31F008-41



组合沙发 SECTIONAL SOFA

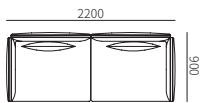

尺寸: 2200\*900\*780mm  
编码: 31F008ZH-01

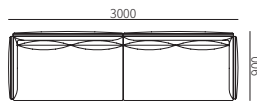

尺寸: 3000\*900\*780mm  
编码: 31F008ZH-02

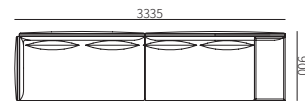

尺寸: 3335\*900\*780mm  
编码: 31F008ZH-03

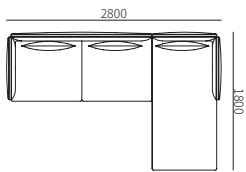

尺寸: 2800\*1800\*780mm  
编码: 31F008ZH-04

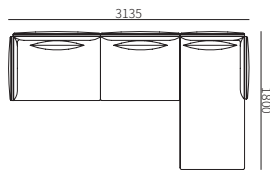

尺寸: 3135\*1800\*780mm  
编码: 31F008ZH-05

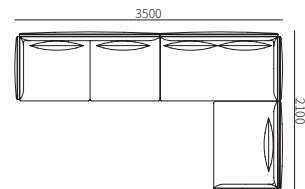

尺寸: 3500\*2100\*780mm  
编码: 31F008ZH-06

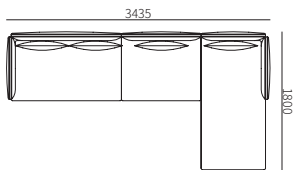

尺寸: 3435\*1800\*780mm  
编码: 31F008ZH-07

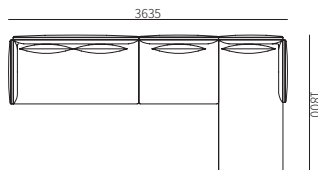

尺寸: 3635\*1800\*780mm  
编码: 31F008ZH-08

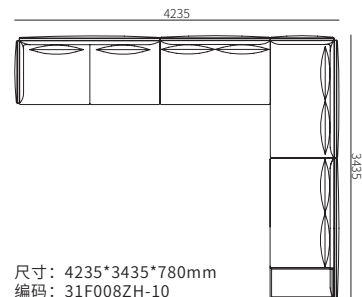

尺寸: 4235\*3435\*780mm  
编码: 31F008ZH-10

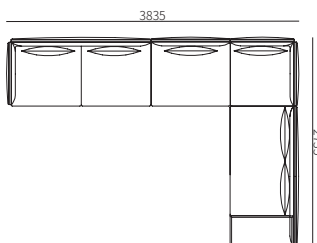

尺寸: 3835\*2735\*780mm  
编码: 31F008ZH-09

# ARMCHAIR

---

单人位



CALA 朵朵  
Yonoh

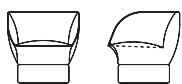

尺寸: 700\*700\*710mm  
编号: 32F004

---

产品描述: 座椅整体为布料或牛皮包制, 底座可转

PRODUCT DESCRIPTION: Upholstered with fabric or leather. Swivels a full 360 degree



## CINI 旖旎

Dainelli Studio

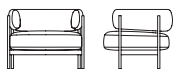

尺寸: 810\*730\*635mm  
编号: 32F012

产品描述: 座椅整体为布料或牛皮包制, 椅腿为不锈钢镀钛

PRODUCT DESCRIPTION: Upholstered with fabric or leather. Stainless steel legs in titanium plating

## GIO 山谷

Christophe Delcourt



尺寸: 680\*900\*800mm  
编号: 32F002

产品描述: 座椅整体为布料或牛皮包制, 椅腿为实木烤漆

PRODUCT DESCRIPTION: Upholstered with fabric or leather. Solid wood legs in black lacquer finish

## MARGARET 麦格

Sebastian Herkner



尺寸: 700\*820\*790mm  
编号: 32F015

产品描述: 座椅整体为布料或牛皮包制, 底框与底脚为黑灰氟碳漆金属

PRODUCT DESCRIPTION: Upholstered with fabric or leather. Metal feet and frame in dark grey epoxy paint finish

## DIAMANTE 多德

Archirivolto Design



尺寸: 800\*780\*800mm  
编号: 32F007

产品描述: 座椅整体为布料或牛皮包制, 靠背和扶手的外侧可选与内侧不同布料或牛皮。底架为黑灰氟碳漆, 底脚为香槟金镀钛不锈钢

PRODUCT DESCRIPTION: Upholstered with fabric or leather. Outside of the chair back can be selected in different colors from the inside. Metal legs in dark grey epoxy paint finish, feet in Champagne gold titanium plating

## BINZ 宾茨

Sebastian Herkner



尺寸: 784\*740\*733mm  
编号: 32F013

产品描述: 座椅整体为布料或牛皮包制, 椅腿为实木开孔漆

PRODUCT DESCRIPTION: Upholstered with fabric or leather. outside of the back in leather only. Legs in solid wood

## BILLIE 嘉年华

Dainelli Studio



尺寸: 710\*660\*680mm  
编号: 32F016

产品描述: 座椅整体为布料或牛皮包制, 底部为香槟金镀钛不锈钢, 带旋转装置

PRODUCT DESCRIPTION: Upholstered in fabric or leather. Swivel stainless steel base in champagne gold titanium plating

## DEBBIE 多彼

Dainelli Studio



尺寸: 700\*750\*820mm  
编号: 32F011

**产品描述:** 座椅外侧靠背及底框为牛皮包制, 内侧靠背及坐垫为布料或与外侧及底框同色牛皮。底腿为黑灰氟碳漆金属

**PRODUCT DESCRIPTION:** Upholstered with fabric or leather. Bottom frame, outside of the back in leather only. Metal feet in dark grey epoxy paint finish

## UOVO 源

Steve Leung 梁志天



尺寸: 850\*850\*700mm  
编号: 32F006

**产品描述:** 座椅整体为布料或牛皮包制, 椅腿为实木开孔漆

**PRODUCT DESCRIPTION:** Upholstered with fabric or leather. Legs in wood

## ROLL 卷儿

Minjing Chen (CAFA) 央美陈旻婧

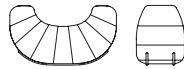

尺寸: 1100\*500\*620mm  
编号: 23F005

**产品描述:** 座椅整体为布料或牛皮包制, 底腿为黑灰氟碳漆金属

**PRODUCT DESCRIPTION:** Upholstered with fabric or leather. Metal feet in dark grey epoxy paint finish

## BOL 元阳

Christophe Delcourt

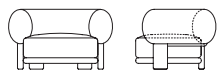

尺寸: 1020\*835\*632mm  
编号: 31F004-11

**产品描述:** 座椅整体为布料, 底框与底脚为实木开孔漆

**PRODUCT DESCRIPTION:** Upholstered with fabric. Frame and feet in solid wood

## UOVO 源

Steve Leung 梁志天



尺寸: 1000\*1000\*755mm  
编号: 31F006-11

**产品描述:** 座椅整体为布料或牛皮包制, 底脚为黑色烤漆金属

**PRODUCT DESCRIPTION:** Upholstered with fabric or leather. Metal feet in black lacquer finish

## QUADRA 嘉里

Yonoh

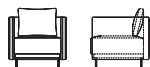

尺寸: 720\*730\*640mm  
编号: 31F008-11

**产品描述:** 座椅整体为布料或牛皮包制, 座椅套可拆洗, 需干洗。底框及底脚为黑镜镀钛不锈钢

**PRODUCT DESCRIPTION:** Upholstered with fabric or leather. Slipcovers can be removed for dry cleaning. Stainless steel frame and feet in black titanium plating

# COFFEE TABLE

茶几



**CRI** 可瑞  
Archirivolto Design



尺寸: D1248\*335mm  
D1048\*335mm  
编号: 41C001 / 41C002

产品描述: 茶几桌面为大理石或木面, 金属腿为香槟金镀钛不锈钢

PRODUCT DESCRIPTION: Table top in marble or wood, Stainless steel frame in champagne gold titanium plating

## FUNGHI 松露

Santiago Sevillano



尺寸: D1200\*345mm  
D1000\*345mm  
编号: 41C033 / 41C034

产品描述: 茶几桌面为木制开孔漆或岩板。底部为玻璃钢烤漆

PRODUCT DESCRIPTION: Table top in wood or stone. Bottom in colored lacquer finish

## DAWN 晓

Ximi Li 李希米



尺寸: D1250\*358mm  
D1050\*358mm  
编号: 41C031

产品描述: 茶几桌面为岩板, 框架为黑灰氟碳漆金属

PRODUCT DESCRIPTION: Table top in stone. Metal frame in dark grey epoxy paint finish

## GATHER 汇

Ximi Li 李希米



尺寸: 1400\*800\*365mm  
1200\*1200\*365mm  
更多尺寸详见官网  
编号: 41C035 / 41C036



产品描述: 茶几桌面为岩板或木质开孔漆。金属架为黑镜镀钛不锈钢。立板为烤漆。底座和抽屉柜为木制开孔漆

PRODUCT DESCRIPTION: Table top in stone or wood. Stainless steel frame in black titanium plating. Side panel in colored lacquer finish. Drawer and bottom panel in wood

## GRASSI 格萨

Sebastian Herkner

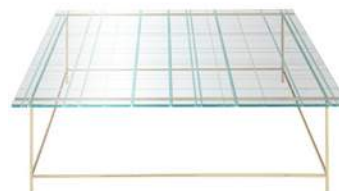

尺寸: 1400\*660\*360mm  
1200\*1200\*360mm  
更多尺寸详见官网  
编号: 41C023



产品描述: 茶几桌面为工艺钢化玻璃, 金属腿为镀钛不锈钢

PRODUCT DESCRIPTION: Table top in tempered glass. Stainless steel frame in titanium plating

## GRANTORINO 都灵

Dainelli Studio



尺寸: 1400\*1000\*320mm  
1200\*900\*320mm  
1000\*700\*320mm  
编号: 41C024 / 41C025



产品描述: 茶几桌面为大理石或木面, 金属腿为黑灰氟碳漆

PRODUCT DESCRIPTION: Table top in marble or wood. Metal frame in dark grey epoxy paint finish

## UOVO 源

Steve Leung 梁志天



尺寸: 1400\*1200\*320mm  
编号: 41C010



产品描述: 茶几桌面为大理石, 底腿为实木开孔漆

PRODUCT DESCRIPTION: Table top in marble. Legs in solid wood

## PLAN 普兰

Archirivolto Design



尺寸: 1400\*1400\*373mm  
1400\*700\*373mm  
更多尺寸详见官网  
编号: 41C006 / 41C009

产品描述: 茶几桌面为大理石或木面, 金属腿为黑镜镀膜钛。

PRODUCT DESCRIPTION: Table top in marble or wood. Metal frame in black titanium.

## GENIE 珍尼

L&L Studio



尺寸: 1400\*900\*382mm  
D600\*510mm  
更多尺寸详见官网  
编号: 41C016 / 41C017

产品描述: 方茶几桌面为大理石, 底板为木制开孔漆, 金属框为黑灰氟碳漆。圆茶几桌面为木制开孔漆, 框架为黑灰氟碳漆。

PRODUCT DESCRIPTION: Rectangular table top in marble, bottom panel in wood. Metal frame in dark grey epoxy paint finish. Round table top in wood. Metal frame in dark grey epoxy paint finish.

## CHESS 纤纤

L&L Studio

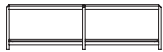

尺寸: D1200\*350mm  
D1000\*350mm  
编号: 41C029 / 41C030

产品描述: 茶几桌面为木制开孔漆或岩板, 底部隔板为木制开孔漆, 框架为镀钛不锈钢。

PRODUCT DESCRIPTION: Table top in wood or stone, bottom panel in wood only. Stainless steel frame in titanium plating.

## CHESS 纤纤

L&L Studio

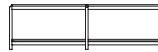

尺寸: 1200\*1200\*350mm  
1400\*900\*350mm  
编号: 41C026 / 41C027

产品描述: 茶几桌面为木制开孔漆或岩板, 底部隔板为木制开孔漆, 框架为镀钛不锈钢。

PRODUCT DESCRIPTION: Table top in wood or stone, bottom panel in wood only. Stainless steel frame in titanium plating.

## TILE 泰然

Yonoh



尺寸: D1200\*400mm  
编号: 41C011/41C012

产品描述: 茶几桌面为大理石或木制开孔漆, 底部收纳区为黑灰氟碳漆, 金属框为黑灰氟碳漆, 底脚为金色镀钛。

PRODUCT DESCRIPTION: Table top in marble or wood. Storage metal box in dark grey epoxy paint finish. Metal frame in dark grey epoxy paint finish and gold titanium plating feet.

## SPHENOID 蝴蝶骨

Hongyu Chen (CAFA) 央美陈虹宇

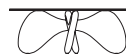

尺寸: D1000\*360mm  
编号: 41C032

产品描述: 茶几桌面为黑色玻璃, 主体为烤漆。

PRODUCT DESCRIPTION: Table top in black color glass. Bottom in colored lacquer finish.



# SIDE TABLE

边几



**STAGE** 云台  
Sebastian Herkner



尺寸: 360\*360\*460mm  
编号: 42C010

产品描述: 角几整体为木制开孔漆

PRODUCT DESCRIPTION: Made in solid wood



## FUNGHI 松露

Santiago Sevillano



尺寸: D500\*500mm  
编号: 42C014 / 42C015

产品描述: 角几桌面为木制开孔漆或岩板。底部为玻璃钢烤漆

PRODUCT DESCRIPTION: Table top in wood or stone. Bottom in colored lacquer finish

## DAWN 晓

Ximi Li 李希米



尺寸: D500\*500mm  
编号: 42C013

产品描述: 角几桌面为棕色 PU 马鞍皮。框架为黑灰氟碳漆金属

PRODUCT DESCRIPTION: Table top in brown saddle leather. Metal frame in dark grey epoxy paint finish

## GATHER 汇

Ximi Li 李希米

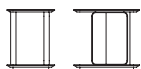

尺寸: 400\*550\*502mm  
400\*550\*505mm  
编号: 42C016 / 42C017

产品描述: 角几桌面为岩板或木质开孔漆。金属架为黑镜镀钛不锈钢。立板为烤漆。底座为木制开孔漆

PRODUCT DESCRIPTION: Table top in stone or wood. Stainless steel frame in black titanium plating. Side panel in colored lacquer finish. Bottom panel in wood

## CONE 科恩

Sebastian Herkner



尺寸: D460\*460mm  
编号: 42C009

产品描述: 角几桌面为中花白大理石, 底座为不锈钢镀铜拉丝

PRODUCT DESCRIPTION: Table top in venato white marble, stainless steel base in brushed brass finish

## CRI 可瑞

Archirivolto Design



尺寸: D648\*449mm  
编号: 41C002-03 / 41C001-03

产品描述: 角几桌面为大理石或木面, 金属腿为香槟金镀钛不锈钢

PRODUCT DESCRIPTION: Table top in marble or wood, Stainless steel frame in champagne gold titanium plating

## ZEN 冰心

Hans Sandgren Jakobsen



尺寸: D354\*404mm  
编号: 42C003

产品描述: 角几整体为镀钛不锈钢

PRODUCT DESCRIPTION: Table made in stainless steel with titanium plating

**OVO 星空**  
Christophe Delcourt

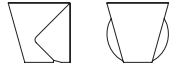

尺寸: 450\*450\*450mm  
编号: 41C007

产品描述: 角几主体为黑色烤漆玻璃钢, 顶圆与侧圆面为杉绿色烤漆

PRODUCT DESCRIPTION: Table made in FRP integrated molding in black lacquered finish, top and side surface in green lacquered finish

**GRANTORINO 都灵**  
Dainelli Studio

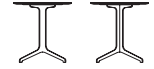

尺寸: 500\*500\*520mm  
编号: 42C007 / 42C008

产品描述: 角几桌面为大理石或木面, 金属腿为黑灰氟碳漆

PRODUCT DESCRIPTION: Table top in marble or wood. Metal frame in dark grey epoxy paint finish

**TILE 泰然**  
Yonoh

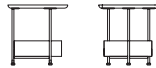

尺寸: D500\*500mm  
编号: 41C011-02 / 41C012-02

产品描述: 茶几桌面为大理石或木制开孔漆, 底部收纳区为黑灰氟碳漆, 金属框为黑灰氟碳漆, 底脚为金色镀钛

PRODUCT DESCRIPTION: Table top in marble or wood. Storage metal box in dark grey epoxy paint finish. Metal frame in dark grey epoxy paint finish and gold titanium plating feet

**CHESS 纤纤**  
L&L Studio

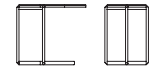

尺寸: 600\*380\*520mm  
编号: 42C011

产品描述: 角几桌面为木制开孔漆或岩板, 框架为镀钛不锈钢

PRODUCT DESCRIPTION: Table top in wood or stone. Stainless steel frame in titanium plating

**PLUS 佳怡**  
Ximi Li 李希米

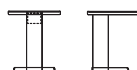

尺寸: D470\*540mm  
编号: 42C005

产品描述: 角几主体为木制开孔漆, 底脚为香槟金镀钛不锈钢

PRODUCT DESCRIPTION: Table made in wood, stainless steel base in champagne gold titanium plating

**LAYER 云层**  
Santiago Sevillano



尺寸: 950\*450\*530mm  
700\*475\*530mm  
编号: 41C008

产品描述: 角几桌面为大理石, 框架为香槟金镀钛不锈钢

PRODUCT DESCRIPTION: Table top in marble. Stainless steel frame in champagne gold titanium plating

## COSMO 魔方

Masayuki Kurokawa 黒川雅之



尺寸: 400\*400\*400mm  
编号: 71C001

产品描述: 角几整体为镀钛不锈钢

PRODUCT DESCRIPTION: Table made in stainless steel with titanium plating

## CONSOLE 条案

### GRANTORINO 都灵

Dainelli Studio

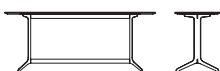

尺寸: 1800\*450\*500mm  
1500\*450\*500mm  
编号: 43C004 / 43C005

产品描述: 条案桌面为大理石或木面, 金属腿为黑灰氟碳漆

PRODUCT DESCRIPTION: Table top in marble or wood. Metal frame in dark grey epoxy paint finish

### LARGO 罗曼

P&P Studio



尺寸: 1800\*400\*850mm  
1500\*400\*850mm  
编号: 13C001

产品描述: 桌面与抽屉柜为木制开孔漆, 底架为黑镜镀钛不锈钢

PRODUCT DESCRIPTION: Table top and drawers in wood. Stainless steel frame in black titanium plating

### MOON 尚月

L&L Studio



尺寸: 1800\*420\*850mm  
1500\*420\*850mm  
1200\*420\*850mm  
编号: 13C003

产品描述: 桌面为木制开孔漆, 底架为镀钛不锈钢

PRODUCT DESCRIPTION: Table top in wood. Stainless steel frame in titanium plating

### MOON 尚月

L&L Studio



尺寸: 1600\*420\*600mm  
1400\*420\*600mm  
1200\*420\*600mm  
编号: 43C003

产品描述: 条案桌面为木制开孔漆, 桌面一端镶嵌圆形岩板。底架为镀钛不锈钢

PRODUCT DESCRIPTION: Table top in wood with stone insert. Stainless steel frame in titanium plating

# LIVING CABINET

## 电视柜



RHYTHM 半岛  
L&L Studio

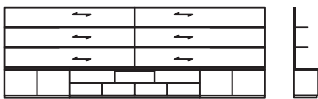

带背板 WITH BACK PANELS

尺寸: 4800\*472\*1664mm 4200\*472\*1664mm  
3600\*472\*1664mm 3300\*472\*1664mm  
3000\*472\*1664mm 2700\*472\*1664mm

编号: 52C004



不带背板 WITHOUT BACK PANELS

尺寸: 4200\*472\*528mm 3600\*472\*528mm  
3300\*472\*528mm 3000\*472\*528mm  
2700\*472\*528mm

**产品描述:** 电视柜柜体与背板为木制开孔漆, 背板铝合金黑丝光烤漆封边, 金属黑丝光烤漆层板, 底柜台面为大理石, 底柜门板和抽屉面为烤漆

**PRODUCT DESCRIPTION:** Storage cabinet and back panel in wood. Back with metal edge banding in black satin finish. Storage cabinet with top in marble, door and drawers front in color lacquer finish

## RHYTHM 半岛

L&L Studio



尺寸: 1200\*500\*630mm  
900\*500\*630mm  
编号: 52C009

产品描述: 电视柜主体为木制开孔漆, 底脚为黑灰氟碳漆

PRODUCT DESCRIPTION: TV stand made in wood with metal feet in dark grey epoxy paint finish

## STRATA 斯巴达

Studio Roderick Vos

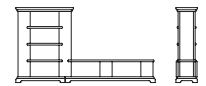

尺寸: 3760\*450\*1542mm  
3460\*450\*1542mm  
3160\*450\*1542mm  
2860\*450\*1542mm  
编号: 52C010

产品描述: 电视柜整体烤漆

PRODUCT DESCRIPTION: Cabinet in colored lacquer finish

## STRATA 斯巴达

Studio Roderick Vos

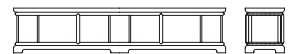

尺寸: 3206\*450\*512mm  
2806\*450\*512mm  
2406\*450\*512mm  
2006\*450\*512mm  
1806\*450\*512mm  
编号: 52C008

产品描述: 电视柜整体烤漆

PRODUCT DESCRIPTION: Made in wood with colored lacquer finish

## LARGO 罗曼

L&L Studio

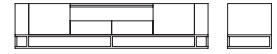

尺寸: 2358\*490\*500mm  
2138\*490\*500mm  
1860\*490\*500mm  
编号: 52C006

**产品描述:** 电视柜主体为开孔漆, 金属底腿为黑镜镀钛不锈钢, 抽屉上方开房区内置烤漆装饰盒

**PRODUCT DESCRIPTION:** Made in wood with stainless steel legs in black titanium plating. Colored lacquer box inside the opening area

## LONJA 龙佳

Santiago Sevillano



尺寸: 2400\*400\*500mm  
2000\*400\*500mm  
编号: 52C001

**产品描述:** 电视柜主体为木制开孔漆, 顶面为大理石, 金属腿为香槟金镀钛不锈钢

**PRODUCT DESCRIPTION:** Made in wood with marble top. Stainless steel legs in champagne gold titanium plating



# DINING TABLE

餐桌



REMBRANT 玲珑  
Achirivolto Design



尺寸: 2400\*1100\*750mm  
2200\*1100\*750mm  
2000\*1100\*750mm  
1800\*1000\*750mm  
1600\*1000\*750mm  
编号: 11C013

产品描述: 餐桌桌面为大理石, 底架为香槟金镀钛不锈钢或者黑灰氟碳漆金属

PRODUCT DESCRIPTION: Dining table top in marble. Stainless steel base in champagne gold titanium plating or metal base in dark grey epoxy paint finish



## SIFF 江月

Christophe Delcourt



尺寸: 2300\*1100\*740mm  
1800\*1100\*740mm  
更多尺寸详见官网  
编号: 11C001

**产品描述:** 餐桌桌面为灰色钢化玻璃, 底腿为灰色钢化玻璃结合木制开孔漆

**PRODUCT DESCRIPTION:** Dining table top in grey tempered glass. Base in the same tempered glass and wood

## BOW 联

Ximi Li 李希米



尺寸: 2400\*1000\*750mm  
1800\*900\*750mm  
更多尺寸详见官网编  
号: 11C020、11C024

**产品描述:** 餐桌桌面为大理石或木制开孔漆, 底座内侧为香槟金镀钛不锈钢, 外侧为黑灰氟碳漆金属

**PRODUCT DESCRIPTION:** Table top in marble or wood. Bottom in dark grey epoxy paint metal and champagne gold titanium plating

## GRID 格韵

Ximi Li 李希米



尺寸: 2600\*1000\*740mm  
1600\*900\*740mm  
更多尺寸详见官网  
编号: 11C021 / 11C025

**产品描述:** 餐桌桌面为木制开孔漆或岩板, 底架为克莱茵兰或黑灰氟碳漆金属

**PRODUCT DESCRIPTION:** Table top in wood or stone. Metal frame in Klein blue or dark grey epoxy paint finish

## FUGUE 富笛

Frank Chou 周宸宸



尺寸: 2400\*1000\*750mm  
1600\*900\*750mm  
更多尺寸详见官网  
编号: 11C017

**产品描述:** 餐桌桌面为木制开孔漆或岩板, 底架为木质开孔漆或黑色烤漆

**PRODUCT DESCRIPTION:** Table top in wood or stone. Legs in wood or in black lacquer.

## FLU 芙蓉

Archirivolto Design



尺寸: 2400\*1100\*750mm  
1600\*1000\*750mm  
更多尺寸详见官网  
编号: 11C015

**产品描述:** 餐桌桌面为大理石或木制开孔漆, 桌腿为实木烤漆

**PRODUCT DESCRIPTION:** Dining table top in marble or wood. Solid wood legs in colored lacquer finish

## GAUDI 高迪

Archirivolto Design



尺寸: D1800\*740mm  
D1600\*740mm  
编号: 11C019

**产品描述:** 餐桌桌面为木制开孔漆, 搭配大理石或烤漆装盘, 底座为镜面不锈钢

**PRODUCT DESCRIPTION:** Dining table top in wood with lazy susan in marble or colored lacquer finish. Stainless steel in mirror finish

## MIAMI 迈阿密

Archirivolto Design



尺寸: D1800\*750mm  
D1600\*750mm  
更多尺寸详见官网  
编号: 11C003 / 11C004

**产品描述:** 餐桌桌面可选大理石搭配同色大理石底座或木制开孔漆桌面搭配中花白大理石底座。可选大理石或烤漆转盘, 金属框为香槟金钛不锈钢

**PRODUCT DESCRIPTION:** Dining table is optional in Marble top with the same base panel or wood top with venato white marble base panel. Lazy susan is optional in marble or colored lacquer finish. Stainless steel frame in champagne gold titanium plating

## POCKY 百吉

Frank Chou 周宸宸



尺寸: D1800\*740mm  
D1400\*740mm  
编号: 11C022 / 11C023

**产品描述:** 餐桌桌面为大理石或木制开孔漆, 底腿为烤漆。餐桌可外置转盘

**PRODUCT DESCRIPTION:** Table top in marble or wood. Bottom in colored lacquer finish. Lazy susan is available



# CHAIR

椅子

---



**LIME** 琳云  
Archiribolto Design



尺寸: 455\*575\*850mm  
编号: 21F009

---

产品描述: 座椅整体为布料或牛皮包制, 椅腿为黑灰氟碳漆金属

PRODUCT DESCRIPTION: Upholstered with fabric or leather. Metal Legs in dark grey epoxy paint finish

## NIVES 彼岸

Archirivolto Design



尺寸: 580\*600\*790mm  
编号: 21F015

产品描述: 座椅为布料或牛皮包制, 椅腿为黑灰氟碳漆金属

PRODUCT DESCRIPTION: Upholstered with fabric or leather. Metal legs in dark grey epoxy paint finish

## MELLOW 云端

Ximi Li 李希米



尺寸: 520\*540\*800mm  
编号: 21F013

产品描述: 座椅为布料或牛皮包制, 椅腿为黑灰氟碳漆金属

PRODUCT DESCRIPTION: Upholstered with fabric or leather. Metal legs in dark grey epoxy paint finish

## NAO 尼奥

Archirivolto Design



尺寸: 446\*568\*890mm  
编号: 21F012

产品描述: 座椅整体为布料或牛皮包制, 椅腿为实木开孔漆

PRODUCT DESCRIPTION: Upholstered with fabric or leather. Legs in solid wood

## NAO 尼奥

Archirivolto Design



尺寸: 446\*568\*810mm  
编号: 21F008

产品描述: 座椅整体为布料或牛皮包制, 椅腿为实木开孔漆

PRODUCT DESCRIPTION: Upholstered with fabric or leather. Legs in solid wood

## NARA 秋叶

Archirivolto Design



尺寸: 560\*610\*800mm  
编号: 21F017

产品描述: 座椅为布料或牛皮包制, 椅腿为实木开孔漆

PRODUCT DESCRIPTION: Upholstered with fabric or leather. Legs in solid wood

## NARA 秋叶

Archirivolto Design



尺寸: 560\*610\*800mm  
编号: 21F016

产品描述: 座椅为布料或牛皮包制, 椅腿为黑灰氟碳漆金属

PRODUCT DESCRIPTION: Upholstered with fabric or leather. Metal legs in dark grey epoxy paint finish

## AGATA 稻香

Archirivolto Design



尺寸: 524\*588\*845mm  
编号: 21F014

产品描述: 座椅为布料或牛皮包制, 椅腿为实木开孔漆

PRODUCT DESCRIPTION: Upholstered with fabric or leather. Legs in solid wood

## ENCONTRA 轻舟

L&L Studio



尺寸: 500\*590\*850mm  
编号: 21F005

产品描述: 座椅整体为布料或牛皮包制, 椅腿为实木开孔漆

PRODUCT DESCRIPTION: Upholstered with fabric or leather. Legs in solid wood

## CHIP 齐贝

Yonoh



尺寸: 539\*525\*772mm  
编号: 21F010

产品描述: 座椅整体为布料或牛皮包制, 椅腿为黑灰氟碳漆金属, 底脚为香槟金镀钛不锈钢

PRODUCT DESCRIPTION: Upholstered with fabric or leather. Metal Legs in dark grey epoxy paint finish, feet in champagne gold titanium plating

## BOLA 飞燕

Yonoh



尺寸: 600\*560\*775mm  
编号: 21F003

产品描述: 座椅整体为布料或牛皮包制, 椅腿为黑丝光烤漆, 底脚为香槟金镀钛不锈钢

PRODUCT DESCRIPTION: Upholstered with fabric or leather. Metal Legs in black satin finish, feet in champagne gold titanium plating

## OHO 燕亭

Christophe Delcourt



尺寸: 500\*580\*800mm  
编号: 21F001

产品描述: 座椅整体为布料或牛皮包制, 椅腿为实木开孔漆

PRODUCT DESCRIPTION: Upholstered with fabric or leather. Legs in solid wood

## UOVO 源

Steve Leung 梁志天



尺寸: 660\*630\*650mm  
编号: 22F001

产品描述: 座椅整体为布料或牛皮包制, 椅腿为实木开孔漆

PRODUCT DESCRIPTION: Upholstered with fabric or leather. Legs in solid wood

## HELLO 哈罗

L&L Studio



尺寸: 485\*495\*1000mm  
485\*495\*900mm  
编号: 25F001

**产品描述:** 整体为布料或牛皮包制, 椅腿为黑灰氟碳漆或镀钛不锈钢

**PRODUCT DESCRIPTION:** Upholstered with fabric or leather. Metal Legs in dark grey epoxy paint finish or stainless steel legs in titanium plating

## PRISMA 万象

Studio Roderick Vos

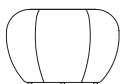

尺寸: 1000\*866\*400mm  
800\*693\*400mm  
600\*519\*400mm  
500\*433\*450mm  
编号: 23F004

**产品描述:** 座椅整体为 Marshmallow 系列布料包制, 底部为黑丝光烤漆金属

**PRODUCT DESCRIPTION:** Upholstered with fabric from the Marshmallow collection. Metal feet in black satin finish

## PULO 布丁

Archirivolto Design



尺寸: D600\*450mm  
D500\*500mm  
编号: 23F001

**产品描述:** 座椅整体为布料或牛皮包制, 椅腿为黑丝光烤漆金属或香槟金镀钛不锈钢

**PRODUCT DESCRIPTION:** Upholstered with fabric or leather. Metal Legs in black satin finish or champagne gold titanium plating

## LONJA 龙佳

Santiago Sevillano

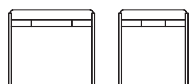

尺寸: 516\*416\*450mm  
编号: 23F002

**产品描述:** 座椅整体为布料或牛皮包制, 椅腿为香槟金镀钛不锈钢

**PRODUCT DESCRIPTION:** Upholstered with fabric or leather. Legs in Champagne gold titanium plating

# SIDEBOARD

餐边柜



**STRATA** 斯巴达  
Studio Roderick Vos

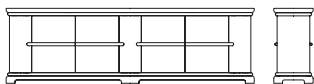

尺寸: 3206\*450\*852mm  
2806\*450\*852mm  
2406\*450\*852mm  
2006\*450\*852mm  
1806\*450\*852mm  
编号: 51C011

产品描述: 边柜整体烤漆

PRODUCT DESCRIPTION: Made in wood with colored lacquer finish



## LEVHIA 璃影

Dainelli Studio

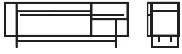

尺寸: 2000\*517\*730mm  
编号: 51C012

产品描述: 主体框架为灰黑钢化玻璃, 柜体为黑檀高光漆

PRODUCT DESCRIPTION: Frame in dark grey tempered glass, drawers in glossy ebony.

## RITA 瑞达

L&L Studio

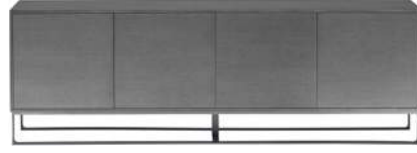

尺寸: 2400\*500\*800mm  
2000\*500\*800mm  
1800\*500\*800mm  
编号: 51C009

产品描述: 边柜主体为木制开孔漆, 金属底腿为黑灰氟碳漆

PRODUCT DESCRIPTION: Made in wood with metal legs in dark grey epoxy paint finish

## LONJA 龙佳

Santiago Sevillano

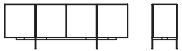

尺寸: 2200\*450\*800mm  
2000\*450\*800mm  
编号: 51C001

产品描述: 边柜主体为木制开孔漆, 顶面为大理石, 金属腿为香槟金电镀钛不锈钢

PRODUCT DESCRIPTION: Made in wood with marble top. Stainless steel legs in champagne gold titanium plating

## LONJA 龙佳

Santiago Sevillano

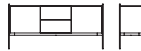

尺寸: 2200\*466\*862mm  
1800\*466\*862mm  
1600\*466\*862mm  
编号: 51C003

产品描述: 边柜主体为木制开孔漆, 顶面为大理石, 金属腿为香槟金电镀钛不锈钢

PRODUCT DESCRIPTION: Made in wood with marble top. Stainless steel legs in champagne gold titanium plating

## LARGO 罗曼

P&P Studio



尺寸: 2000\*500\*750mm  
1800\*500\*750mm  
1500\*500\*750mm  
编号: 51C004

产品描述: 边柜主体为木制开孔漆, 底腿为黑镜镀膜钛不锈钢

PRODUCT DESCRIPTION: Made in wood with stainless steel legs in black titanium plating

## RITA 瑞达

L&L Studio



尺寸: 1200\*454\*1500mm  
编号: 51C010

产品描述: 酒柜主体为木制开孔漆, 开放区域内置烤漆内盒, 底脚为黑灰氟碳漆金属

PRODUCT DESCRIPTION: Wine cabinet made in wood. Colored lacquer box inside the opening area. Metal feet in dark grey epoxy paint finish

# BED & BEDSIDE TABLE

床 & 床头柜



**UOVO** 源  
Steve Leung 梁志天

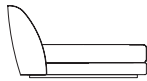
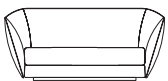

尺寸: 2550\*2285\*1080mm (床垫 2000\*2000mm)    2350\*2285\*1080mm (床垫 1800\*2000mm)  
2150\*2285\*1080mm (床垫 1600\*2000mm)    2050\*2285\*1080mm (床垫 1500\*2000mm)  
编号: 61F002

产品描述: 床为布料或牛皮包制, 床脚为实木开孔漆

PRODUCT DESCRIPTION: Upholstered with fabric or leather, feet in solid wood

## BARRY 百瑞

Ximi Li 李希米



**产品描述:** 床外侧为牛皮包制, 床内侧与床笠可选择面料或与外侧同色牛皮。底脚为黑灰氟碳漆金属



尺寸: 2325\*2293\*1050mm (床垫 2000\*2000mm)  
2125\*2293\*1050mm (床垫 1800\*2000mm)  
1925\*2293\*1050mm (床垫 1600\*2000mm)  
1825\*2293\*1050mm (床垫 1500\*2000mm)  
编号: 61F010 / 61F011

**PRODUCT DESCRIPTION:** Upholstered with fabric or leather, outside of the back in leather only. Metal feet in dark grey epoxy paint finish

## MELLOW 云端

Ximi Li 李希米



**产品描述:** 床为布料或牛皮包制, 床腿为黑灰氟碳漆金属



尺寸: 2420\*2215\*1100mm (床垫 2000\*2000mm)  
2220\*2215\*1100mm (床垫 1800\*2000mm)  
1920\*2215\*1100mm (床垫 1500\*2000mm)  
1620\*2215\*1100mm (床垫 1200\*2000mm)  
编号: 61F013

**PRODUCT DESCRIPTION:** Upholstered with fabric or leather, Metal feet in dark grey epoxy paint finish

## LALALAND 爱乐

L&L Studio



**产品描述:** 床为布料或牛皮包制, 床腿为黑丝光烤漆金属。含床箱



尺寸: 2500\*2400\*1020mm (床垫 2000\*2000mm)  
2300\*2400\*1020mm (床垫 1800\*2000mm)  
2000\*2400\*1020mm (床垫 1500\*2000mm)  
1850\*2400\*1020mm (床垫 1350\*2000mm)  
编号: 61F012

**PRODUCT DESCRIPTION:** Upholstered with fabric or leather. Metal feet in black satin finish. Bed includes hidden storage compartment

**CITTI 西提**  
Frank Chou 周宸宸



产品描述：床为布料或牛皮包制，床底框为木制黑色漆

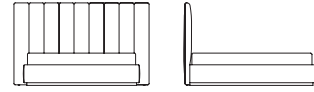

尺寸：2500\*2175\*1300mm (床垫 2000\*2000mm)  
1500\*2175\*1300mm (床垫 1500\*2000mm)  
更多尺寸详见官网  
编号：61F007

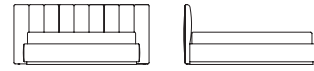

尺寸：2500\*2175\*1040mm (床垫 2000\*2000mm)  
1500\*2175\*1040mm (床垫 1500\*2000mm)  
更多尺寸详见官网  
编号：61F001

**PRODUCT DESCRIPTION:** Upholstered with fabric or leather, wooden base frame in black painting finish

**LONJA 龙佳**  
Santiago Sevillano



产品描述：床为布料或牛皮包制，底脚为香槟金镀钛不锈钢

带床尾板 WITH FOOTBOARD

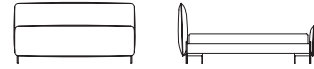

尺寸：2210\*2270\*1100mm (床垫 2000\*2000mm)  
2010\*2270\*1100mm (床垫 1800\*2000mm)  
1810\*2270\*1100mm (床垫 1600\*2000mm)  
1710\*2270\*1100mm (床垫 1500\*2000mm)  
编号：61F003

无床尾板 WITHOUT FOOTBOARD

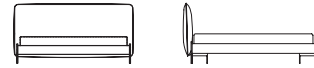

尺寸：2210\*2215\*1100mm (床垫 2000\*2000mm)  
2010\*2215\*1100mm (床垫 1800\*2000mm)  
1810\*2215\*1100mm (床垫 1600\*2000mm)  
1710\*2215\*1100mm (床垫 1500\*2000mm)  
编号：61F008

**PRODUCT DESCRIPTION:** Upholstered with fabric or leather. Stainless steel frame in champagne gold titanium plating

**FUGUE 富笛**  
Frank Chou 周宸宸



产品描述：床为布料或牛皮包制，底脚为黑丝光烤漆金属

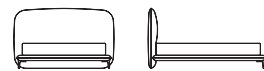

尺寸：2320\*2260\*1150mm (床垫 2000\*2000mm)  
2120\*2260\*1150mm (床垫 1800\*2000mm)  
1920\*2260\*1150mm (床垫 1600\*2000mm)  
1820\*2260\*1150mm (床垫 1500\*2000mm)  
编号：61F006

**PRODUCT DESCRIPTION:** Upholstered with fabric or leather. Metal feet in black satin finish

## HOOP 霍普

L&L Studio

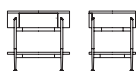

尺寸: 560\*420\*540mm  
编号: 53C010

产品描述: 床头柜主体为木制开孔漆, 金属腿为黑灰氟碳漆

PRODUCT DESCRIPTION: Made in wood with metal Legs in dark grey epoxy paint finish

## ANNI 悠然

L&L Studio

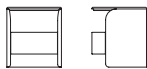

尺寸: D500\*550mm  
编号: 53C002

产品描述: 床头柜主体为木制开孔漆, 顶面与抽屉正面为烤漆

PRODUCT DESCRIPTION: Made in wood with top and drawer front in colored lacquer finish

## LONJA 龙佳

Santiago Sevillano



尺寸: 516\*466\*540mm  
编号: 53C004 / 53C005

产品描述: 床头柜主体为木制开孔漆, 抽屉正面为烤漆或木制开孔漆, 金属框为香槟金镀钛不锈钢

PRODUCT DESCRIPTION: Made in wood with drawer front in colored lacquer finish or wood. Stainless steel legs in champagne gold titanium plating

## RITA 瑞达

L&L Studio

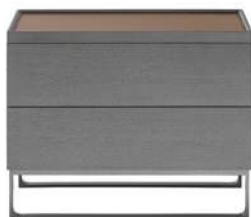

尺寸: 700\*480\*500mm  
600\*480\*500mm  
编号: 53C007

产品描述: 床头柜主体为木制开孔漆, 桌面为皮质, 底腿为黑灰氟碳漆金属

PRODUCT DESCRIPTION: Made in wood with leather top insert. Metal feet in dark grey epoxy paint finish

## BELLA 贝拉

L&L Studio



尺寸: 700\*495\*500mm  
编号: 53C008

产品描述: 床头柜主体为木制开孔漆, 桌面为皮质。产品分左右

PRODUCT DESCRIPTION: Made in wood with leather top insert. Available in both left and right unit

## LARGO 罗曼

L&L Studio



尺寸: 2138\*490\*670mm  
1860\*490\*670mm  
1660\*490\*670mm  
编号: 52C007

**产品描述:** 主体为开孔漆, 金属底腿为黑镜镀钛不锈钢, 抽屉上方开房区内置烤漆装饰盒

**PRODUCT DESCRIPTION:** Made in wood with stainless steel legs in black titanium plating. Colored lacquer box inside the opening area

## BELLA 贝拉

L&L Studio

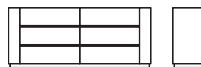

尺寸: 1906\*450\*800mm  
1506\*450\*800mm  
编号: 52C005

**产品描述:** 床头柜主体为木制开孔漆, 桌面为皮质

**PRODUCT DESCRIPTION:** Made in wood with leather top insert

## LONJA 龙佳

Santiago Sevillano



尺寸: 1300\*450\*1270mm  
编号: 14C002

**产品描述:** 主体为木制开孔漆, 金属框与镜框为香槟金镀钛不锈钢

**PRODUCT DESCRIPTION:** Made in wood with stainless steel legs and mirror frame in champagne gold titanium plating

## LARGO 罗曼

P&P Studio



尺寸: 1200\*450\*1270mm  
尺寸: 1000\*450\*1270mm  
编号: 14C001

**产品描述:** 主体为木制开孔漆, 底腿为黑镜镀钛金属

**PRODUCT DESCRIPTION:** Made in wood with metal frame in black titanium finish

## PLUS 佳怡

Ximi Li 李希米



尺寸: 480\*470\*1270mm  
编号: 53C006

**产品描述:** 主体为木制开孔漆, 衣架为镀钛不锈钢

**PRODUCT DESCRIPTION:** Made in wood with stainless steel shelf in titanium plating

## LONJA 龙佳

Santiago Sevillano



尺寸: 1184\*414\*1820mm  
编号: 56C001

**产品描述:** 整体框架和底层层板为香槟金镀钛不锈钢, 中间条几为木制开孔漆, 包含软包布料或皮质坐垫。左侧中花白大理石托盘, 下方另有木制开孔漆储物盒, 右侧挂镜香槟金镀钛不锈钢镶边

**PRODUCT DESCRIPTION:** Stainless steel frame and bottom panel in champagne gold titanium plating. Bench in wood with fabric or leather cushion. Left side includes a marble surface and wood storage, right side includes a mirror with frame in champagne gold titanium plating

## BARRY 百瑞

Ximi Li 李希米

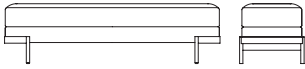

尺寸: 1810\*485\*450mm  
1610\*485\*450mm  
编号: 24F003

产品描述: 座椅整体为布料或牛皮包制, 椅腿为黑灰氟碳漆

PRODUCT DESCRIPTION: Upholstered with fabric or leather. Metal Legs in dark grey epoxy paint finish

## CITTI 西提

L&L Studio

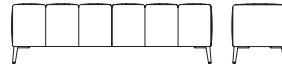

尺寸: 1750\*420\*450mm  
1500\*420\*450mm  
编号: 24F002

产品描述: 座椅整体为布料或牛皮包制, 底脚为黑丝光烤漆金属

PRODUCT DESCRIPTION: Upholstered with fabric or leather. Metal feet in black satin finish

## LONJA 龙佳

Santiago Sevillano

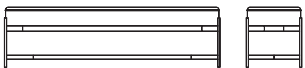

尺寸: 1816\*416\*450mm  
1616\*416\*450mm  
编号: 24F001

产品描述: 座椅整体为布料或牛皮包制, 椅腿为香槟金镀钛不锈钢

PRODUCT DESCRIPTION: Upholstered with fabric or leather. Stainless steel legs in Champagne gold titanium plating

# DESK & BOOKCASE

书桌 & 书架



**STRATA** 斯巴达  
Studio Roderick Vos

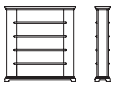

尺寸: 1760\*400\*1870mm  
1760\*400\*1530mm  
1560\*400\*1870mm  
1560\*400\*1530mm  
编号: 55C004

产品描述: 书柜整体烤漆

PRODUCT DESCRIPTION: Made in wood with colored lacquer finish



## UO 优沃

Hi Thanks Bye



尺寸: 610\*619\*1788mm  
编号: 71C008

**产品描述:** 置物架两侧板为岩绿色木制烤漆, 内置隔板为艳绿色金属烤漆

**PRODUCT DESCRIPTION:** Front and back wood panel and metal shelves and frame are all in green lacquer finish

## RHYTHM 半岛

L&L Studio

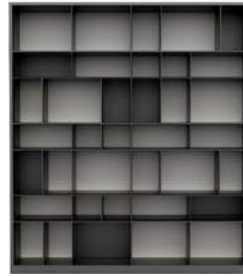

组合尺寸: 2374\*357\*2697mm  
3526\*357\*2697mm  
4390\*357\*2697mm

2374\*357\*2401mm  
3526\*357\*2401mm  
4390\*357\*2401mm

2374\*357\*1975mm  
3526\*357\*1975mm  
4390\*357\*1975mm  
更多尺寸详见官网

编号: 55C002 / 55C003

**产品描述:** 书架主体为烤漆或木制开孔漆, 背板为白色哑光烤漆

**PRODUCT DESCRIPTION:** Cabinet frame and shelves in wood or lacquer finish. Back panel in white lacquer finish only

## LARGO 罗曼

P&P Studio



尺寸: 1600\*600\*760mm  
1400\*600\*760mm  
1200\*600\*760mm  
编号: 12C001

**产品描述:** 桌面与抽屉柜为木制开孔漆, 底架为黑镜镀钛不锈钢

**PRODUCT DESCRIPTION:** Table top and drawers in wood. Stainless steel frame in black titanium plating

## GATHER 汇

Ximi Li 李希米



尺寸: 2380\*980\*750mm  
2080\*980\*750mm  
1800\*900\*750mm  
编号: 12C002

**产品描述:** 书桌桌面及抽屉柜为木制开孔漆, 金属框架与腿为黑镜镀钛, 立腿为烤漆

**PRODUCT DESCRIPTION:** Desk top and drawers in wood. Metal frame in black titanium plating, side panel in colored lacquer finish

# ACCESSORY 配饰

## ILLUSION 叠影

MARIO TSAI 蔡烈超

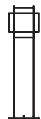

尺寸: 450\*450\*1500mm  
编号: 72C001

产品描述: 整体香槟金镀钛不锈钢

PRODUCT DESCRIPTION: Whole piece in champagne titanium plating stainless steel

## COSMO 星际

Masayuki Kurokawa 黒川雅之



尺寸: 40\*40\*40mm  
编号: 71C007

产品描述: 整体黄铜拉丝或者透明亚克力

PRODUCT DESCRIPTION: Whole piece in brushed brass or clear acrylic

## FLYING MIRROR 飞镜

MARIO TSAI 蔡烈超



尺寸: 600\*400\*50mm  
编号: 71C003

产品描述: 镜面和香槟金镀钛不锈钢

PRODUCT DESCRIPTION: Mirror with champagne titanium plating stainless steel



尺寸: 500\*550\*50mm  
编号: 71C004

产品描述: 镜面和香槟金镀钛不锈钢

PRODUCT DESCRIPTION: Mirror with champagne titanium plating stainless steel

# RUG 地毯

## CORNICE 漫步

Studio Roderick Vos

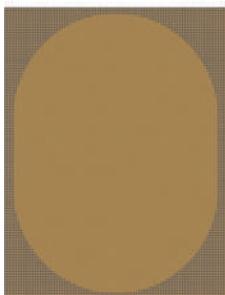

尺寸: 3442\*4500mm  
3060\*4000mm  
2612\*3500mm  
2326\*3200mm  
编号: 76C001-76C004

表面效果: 新西兰羊毛加丝

PRODUCT DESCRIPTION: New Zealand wool with silk

## HALO 追光者

Studio Roderick Vos

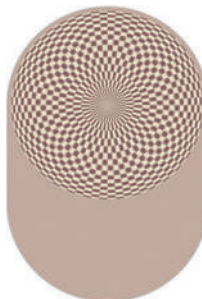

尺寸: 3000\*4500mm  
2667\*4000mm  
2334\*3500mm  
2134\*3200mm  
编号: 76C005-76C007

表面效果: 新西兰羊毛加丝

PRODUCT DESCRIPTION: New Zealand wool with silk

## TUMBLE 探帛

Studio Roderick Vos



尺寸: 3015\*4500mm  
2670\*4000mm  
2345\*3500mm  
2144\*3200mm  
编号: 76C008, 76C009, 76C016

表面效果: 100% 新西兰羊毛

PRODUCT DESCRIPTION: 100% New Zealand wool

## SPLICE 思莱

Studio Roderick Vos



尺寸: 1980\*3060mm  
2265\*3500mm  
2588\*4000mm  
2912\*4500mm  
2000\*3500mm  
2000\*4000mm  
2500\*4000mm  
2500\*4500mm  
编号: 76C010-76C015

表面效果: 50% 新西兰羊毛 + 50% 人棉丝

PRODUCT DESCRIPTION: 50% New Zealand wool + 50% Visco



